

PAPERLESS RECORDER

USER MANUAL



SKU: SISCO-PLR-CH40

FOREWORD

Thank you for purchasing our paperless recorder!

This manual is about the functions, settings, wiring methods, methods of operation, treatment methods to failure of the paperless recorder. To ensure correct use, please read this manual carefully and use properly before operation and keep this manual in a safe place for quick reference.

Notice

- The contents of this manual are subject to change without prior notice as a result of continuing upgrades to the instrument's performance and functions.
- Every effort has been made in the preparation of this manual to ensure the accuracy of its contents. However, if you have any questions or find any errors, please feel free to contact us.
- Copying or reproducing all or any part of the contents of this manual without our permission is strictly prohibited.

SAFETY PRECAUTIONS

The following general safety precautions must be observed during all phases of operation. If the Instrument is used in a manner not specified in this manual, the protection provided by the Instrument may be impaired. We assume no liability for the customer's failure to comply with these requirements.

WARNING

- **Power Supply**

Before connecting the power cord, ensure that the power supply voltage matches the voltage rating for the instrument.

- **Protective Grounding**

Make sure to connect the protective grounding to prevent electric shock before turning ON the power.

- **Necessity of Protective Grounding**

Never cut off the internal or external protective grounding wire or disconnect the wiring of the protective grounding terminal. Doing so will pose a potential shock hazard.

- **Defect of Protective Grounding**

Do not operate the instrument when the protective grounding or the fuse might be defective. Also, make sure to check them before operation.

- **Do Not Operate in Explosive Atmosphere**

Do not operate the instrument in the presence of flammable liquids or vapors.

Operation of any electrical instrument in such an environment constitutes a safety hazard.

- **Do Not Remove Covers**

Some areas inside the instrument have high voltages. Do not remove the cover if the power supply is connected. The cover should be removed by our qualified personnel only.

- **External Connection**

Connect the protective grounding before connecting to the item under measurement or control unit.

- **Damage to the protection**

Using the instrument in a manner not specified in this manual can damage the instrument's protection

CHECKING THE CONTENTS OF THE PACKAGE

Unpack the box and check the contents before operating the instrument. If some of the contents are not correct or missing or if there is physical damage, contact the dealer from which you purchased them.

There is a name plate on the left side of the instrument’s body. Open the cover and check that the model name and code given on the name plate match those on the order.

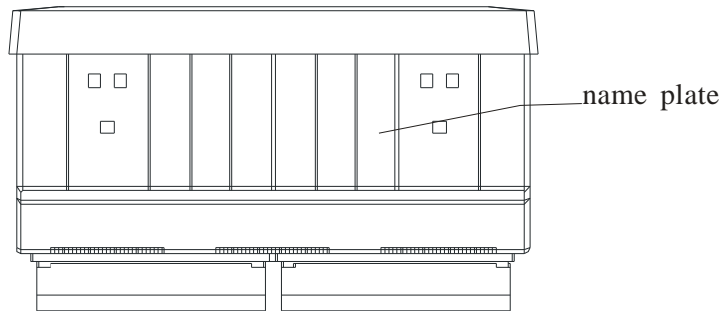

Standard Accessories

The following standard accessories are supplied with the instrument. Make sure that all items are present and undamaged.

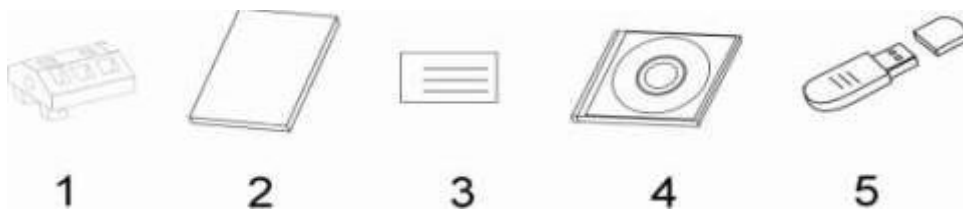

Number	Name	Quantity	Notes
1	Mounting bracket	4	For panel mounting
2	User's Manual	1	This manual
3	Certificate	1	Manufacture Date
4	Standard Software	1	Provided a CD-ROM (Included only when the Communication or External storage is ordered.) For Windows XP
5	U Disk	1	Included only when the External storage is ordered. Capacity and model of the USB Storage may vary.

Accessories (Sold Separately)

The following optional accessories are available for purchase separately. If you make an order, make sure that all items are present and undamaged.

For information about ordering accessories, contact the dealer from which you purchased the instrument.

Number	Name	Quantity	Notes
1	U Disk	1	2GB 4GB

HOW TO USE THIS MANUAL

Structure of the Manual

This user's manual consists of the following 12 chapters:

Chapter	Title and Contents
1	Overview of Functions Describes the functions of the instrument.
2	Before Using the Instrument Describes the installation and wiring procedures.
3	Names of Parts/Run Mode/Common Operations Describes the names of each part of the instrument, how to use the storage medium drive, run mode, and common key operations.
4	Switching Display Screens Describes how to use the operation screen such as the trend display and digital display. Describes the operations that can be performed using the arrow keys, page key and the enter key on the front panel.
5	System Configurations Describes the related parameters of the running system.
6	Setting Signal Input parameters Describes how to set input channel parameters
7	Setting Alarms Parameters Describes how to set alarms and relays.
8	Setting Analog Outputs Describes how to set analog outputs specifications
9	Data acquisition and backup Describes how to acquire the measured/computed data and how to save the data to the external storage medium.
10	Setting Communication Parameters Describes how to set communication parameters and how to use the mini-printer to connect the instrument
11	Initializing Data Purge the accumulation , and alarm report, resume factory setting
12	Specifications Lists the specifications of the Paperless Recorder.

Conventions used in this manual

Unit

- K Denotes "1024"
- K Denotes "1000"
- M Denotes "1024K"
- G Denotes "1024M"
- B "Bytes"

Symbols

WARNING : Describes precautions that should be observed to prevent injury or death to the user.

CAUTION : Describes precautions that should be observed to prevent minor or moderate injury, or damage to the instrument.

Note : Provides important information for the proper operation of the instrument.

Notation regarding procedures

On pages that describe the operating procedures the following symbols are used to distinguish the procedures from their explanations.

[] Represent key's name. Example: [Page] [En]

『 』Indicate a reference item. Example: 『 Input Setting 』

Content

FOREWORD.....	I
SAFETY PRECAUTIONS.....	II
CHECKING THE CONTENTS OF THE PACKAGE.....	III
HOW TO USE THIS MANUAL	V
CHAPTER 1 OVERVIEW OF FUNCTIONS.....	1
1.1 OVERVIEW OF THE INSTRUMENT	1
1.2 FUNCTIONS OF THE INPUT SECTION	2
1.3 DISPLAY FUNCTION.....	5
1.4 STORAGE FUNCTION.....	7
1.5 ALARM FUNCTION.....	8
1.6 COMPUTATION FUNCTION (OPTION)	9
1.7 OUTPUT FUNCTION (OPTION).....	10
1.8 COMMUNICATION FUNCTION (OPTION).....	11
1.9 OTHER FUNCTIONS	12
CHAPTER 2 BEFORE USING THE INSTRUMENT	13
2.1 PRECAUTIONS ON THE USE OF THE INSTRUMENT	13
2.2 INSTALLING THE INSTRUMENT	14
2.3 INPUT AND OUTPUT SIGNAL WIRING.....	17
2.4 ALARM OUTPUT WIRING (OPTION).....	21
2.5 INPUT DIGITAL SIGNAL WIRING (OPTION).....	23
2.6 CONNECT POWER SUPPLY	25
2.7 24VDC TRANSMITTER POWER WIRING (OPTION)	27
2.8 RS232C/RS485 COMMUNICATION WIRING (OPTION).....	29
CHAPTER 3 NAMES OF PARTS/RUN MODE/COMMON OPERATIONS	31
3.1 NAMES OF PARTS AND FUNCTIONS	31
3.2 INSERTING/REMOVING THE EXTERNAL STORAGE MEDIUM.....	34
3.3 RUN MODE	35
3.4 CONFIGURING THE FUNCTIONS	37
3.5 COMMON KEY OPERATIONS	38
CHAPTER 4 SWITCHING OPERATION SCREENS	42
4.1 SWITCHING OPERATION SCREENS	42
4.2 EXPLANATION OF THE STATUS DISPLAY SECTION.....	43
4.3 DIGITAL DISPLAY SCREEN	44
4.3.1 LARGER DISPLAY SCREEN	45
4.4 BAR GRAPH DISPLAY.....	46
4.5 REAL-TIME TREND SCREEN	47
4.6 HISTORY TREND SCREEN.....	50
4.7 ALARM SUMMARY	52
4.8 REPORT	53
CHAPTER 5 SYSTEM CONFIGURATIONS.....	58
5.1 SETTING THE DATE AND TIME	58
5.2 SETTING THE ALALIS	59

5.3 SETTING THE SYSTEM PASSWORD	60
5.4 SETTING THE SCREEN BRIGHTNESS.....	61
5.5 SETTING TREND DIRECTION AND TREND COMBINATGION	62
5.6 VIEW SYSTEM INFORMATION.....	64
CHAPTER 6 INPUT SIGNAL SETTINGS.....	65
6.1 INPUT TYPE AND SCALING SETTING	65
6.2 INPUT VACUUM TYPE AND SCALING SETTING.....	68
6.3 CHANNEL TAG AND UNIT SETTING	70
6.4 INPUT FILTER SETTING	71
6.5 BURNOUT SETTING	72
6.6 REFERENCE JUNCTION COMPENSATION.....	73
6.7 ACCUMULATION SETTING	74
6.8 COPYING CHANNEL PARAMETERS.....	75
6.9 SQUARE ROOT COMPUTATION AND SMALL SIGNAL CUTTING	76
CHAPTER 7 SETTING ALARMS.....	78
7.1 CHANNEL ALARM SETTING	78
CHAPTER 8 SETTING ANALOG OUTPUTS	81
8.1 ANALOG OUTPUTS SETTING.....	81
CHAPTER9 DATA STORAGE AND BACKUP.....	82
9.1 SETTING THE SAVING INTERVAL OF DATA STORAGE.....	82
9.2 SAVING HISTORIACL DATA TO EXTERNAL STORAGE MEDIUM.....	85
CHAPTER 10 SETTING COMMUNICATION PARAMETERS.....	87
10.1 COMMUNICATION USING RS232C (OPTION)	87
10.2 COMMUNICATION USING RS485 (OPTION)	89
10.3 CONNECT WITH MICRO PRINTER (OPTION)	91
10.4 TIMER PRINT FUNCTION SETTING	92
CHAPTER 11 INITIALIZING DATA.....	93
11.1 RESTORE FACTORY SETTING.....	93
11.2 PURGE ALARM SUMMARY	96
11.3 PURGE ACCUMULATION REPORT.....	97
CHAPTER 12 SPECIFICATIONS.....	98
12.1 SIGNAL INPUT AND ALARM.....	98
12.2 DISPLAY SPECIFICATIONS	100
12.3 DATA STORAGE SPECIFICATIONS.....	102
12.4 OTHER STANDARD FUNCTIONS	103
12.5 SELECT FITTINGS	104
12.6 GENERAL SPECIFICATIONS	106
12.7 EXTERNAL DIMENSION.....	109

CHAPTER 1 OVERVIEW OF FUNCTIONS

1.1 OVERVIEW OF THE INSTRUMENT.

Unlike conventional record that record data on charts, the Instrument displays the measured /computed data acquired in the internal memory to a LCD. The measured data can also be saved to external storage media such as U Disk (option).

Measured/ operational data can be used as displayed data stored in the memory, or you can also insert the external storage to save it in the external storage media through the manual backup.

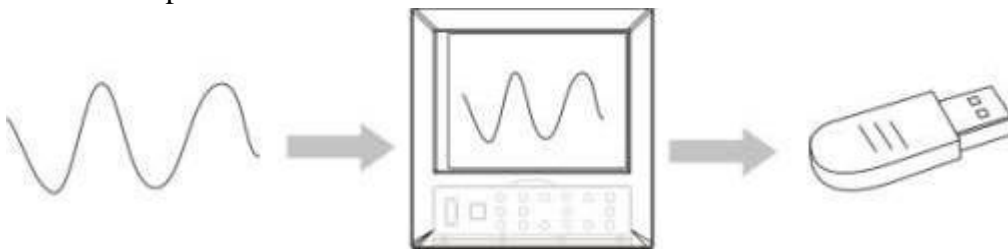

Displayed data is shown as curves and other data on meter screen. It is the data filter out from the samples by the instrument. A datum is equivalent to a point on the curve of the screen. The time of a datum is determined by recorded meter intervals. Historical data is equivalent to the original recording paper, which is very suitable for long-time observation.

1.2 FUNCTIONS OF THE INPUT SECTION

Number of Measurement Channels/Scan Interval

The number of measurement channels can be selected from 1~40.

The scan interval of measurement is 1 second.

Input Type and Computation

You can select the input type of a measurement channel as follows. You can also perform computation for instance, the “square root,” on the measured data. For the procedure related to setting the different modes, see section 『 channels measurement configurations』

Input Mode	Range
DC current	0–10mA 4–20mA
DC voltage	0–20mV 0–100mV 0–5V 1–5V 0–10V
Resistance	0 – 350Ω
Thermocouple	S、 B、 K、 T、 E、 J、 R、 N、 F1、 F2、 WRE
Thermal Resistance	PT100、 Cu50、 BA1、 BA2
Frequency signal	0 – 10000Hz

Input Range and Measurable Range

You can select the “Input range” that is appropriate for the input signal in “DC current,” “DC voltage,” “Resistance,” “Thermocouple” “Thermal Resistance,” “Frequency signal”.

For each “Input range,” a measurable range is defined.

Burnout

When measuring temperature with a thermocouple and the thermocouple burns out, you can specify the measurement result to be set to maximum of measurable range, minimum of measurable range, last value or Error Flag*1. For the setting procedure, see section 『Burnout setting』

*1 when the burnout setting is Error Flag, the measured value is indicated as “**.*”.

Reference Junction Compensation (RJC)

When measuring the temperature using a thermocouple, the reference junction compensation can be used. Reference junction compensation current is installed. You can adjust the temperature that measured by the instrument. For the setting procedure, see section 『reference junction compensation』 .

Filter

The filter is used to suppress the disturbance that is curbing the signal. Filtering is provided by the standard products. The filter can be set on each channel. For the setting procedure, see section 『set input filter parameter』 .

























1.3 DISPLAY FUNCTION

Common Items Related to the Display

TFT Color LCD and the Screen Configuration

The instrument has a 10.4" TFT color LCD (640-by-480 dot resolution).

The screen consists of the status display section and the data display section.

Value		2010-06-20 10:08:20	
Chnl01 38.24 %		Chnl02 38.24 %	
Chnl03 38.24 %		Chnl04 38.24 %	
Chnl05 38.24 %		Chnl06 38.24 %	
Chnl07 38.24 %		Chnl08 38.24 %	
Chnl09 38.24 %		Chnl10 38.24 %	
Chnl11 38.24 %		Chnl12 38.24 %	
Chnl13 38.24 %		Chnl14 38.24 %	
Chnl15 38.24 %		Chnl16 38.24 %	
Chnl17 38.24 %		Chnl18 38.24 %	
Chnl19 38.24 %		Chnl20 38.24 %	
Chnl21 38.24 %		Chnl22 38.24 %	
Chnl23 38.24 %		Chnl24 38.24 %	

Page

1. Status Display Section

Display the screen name, date and time, input acquisition board status, relay output status, USB devices connection (additional specifications), cycle display signs, searching status. For details, see section 『 status display』 .

2. Data Display Section

Display the operation screen such as the digital display, bar graph display and trend display or the operation screen of alarm, print, etc.

When it has function configuration, display configuration mode.

Group display

The data shown in the trend screen is assigned to group measurement channel or data channel operations. A group can select channels 1-8, for the methods to assign the channel to groups , please refer to 『 set the trend direction and combination』 . It can log 5 groups, only effective in the trend screen.

Run Mode

This mode is entered when the power is turned ON.

Display various operation screens such as signal's digital, alarm status, trend, historical trend, alarm summary.

Running condition is under a number of remarkable figure images, including digital display screen, bar graph screen, real-time curve screen, history curve screen, the alarm list screen.

Setting Mode

The various functions of the instrument are configured using the setting mode.

This screen is used to set the parameters of signal type, input range, digital filter, alarm, group , time, etc.

LCD screen atmosphere

To set the following screen atmosphere before use.

Screen atmosphere	Content
LCD brightness	Meter brightness: adjust from 0% to 100%; the initial value is 10%.

1.4 STORAGE FUNCTION

The instrument can save measured data and computed data, which are first acquired to the instrument's internal memory as display data. Then, the data are saved to the external storage medium on paper. For detail, see section 『s data storage and backup 』.

External Storage Media

Various data can be saved to the U disk. The capacity is from 256MB to 1GB.

Measurement period and Recording Interval

The scan interval of signal is fixed at 1s. The measuring and computing are completed in every scan interval. Display data is generated by these data.

Recording Interval is used by the instrument to record the time interval of data which is saved to the internal memory.

Saving Data to Internal Memory

The display data are saved to internal memory continuously by saving interval. If the instrument is unplugged, the data that lost while unplugged will be complemented when the power is turned ON.

Data will be written to the internal memory according to recording interval.

Saving Data to External Storage Media

Insert the storage media into the drive; enter the [data backup] screen, back up the data from the internal memory of the instrument to external storage media.

1.5 ALARM FUNCTION

This function generates an alarm when the measured/computed data meets a certain condition. When an alarm occurs, information notifying the alarm occurrence is displayed on the screen, which is displayed as alarm icons in the status display section. In addition, a signal can be output from the relay output terminals on the rear panel of the instrument (Option). For details, see section 『Setting Alarms』.

Types of Alarms

You can set up to four alarms for each channel.

- High alarm (H)

An alarm occurs when the measured value exceeds the alarm value.

- Low alarm (L)

An alarm occurs when the measured value falls below the alarm value.

- High high alarm (HH)

An alarm occurs when the measured value exceeds the alarm value.

- Low low alarm (LL)

An alarm occurs when the measured value falls below the alarm value.

Alarm Accessibility

Use the following auxiliary functions

Function	Content
Alarm Hysteresis	Set any hysteresis within the range
Alarm relay output (additional specifications)	When alarm occurs, output contacts signal

Alarm display

Show alarm icon in the alarm status display column or show alarm state in the multi channel digital display screen.

1.6 COMPUTATION FUNCTION (OPTION)

The accumulation computation can be performed.

Accumulation Computation

The accumulation computation is performed every second.

The accumulation computation can be performed on each measurement channel.

For detail, see section 『Channel Accumulation Setting』

1.7 OUTPUT FUNCTION (OPTION)

Measured data can be transmitted and output as an analog signal.

Transmitter Output

The signal type of transmitter output is 4-20mA.

The instrument provides 8 channels transmitter output.

The maximum load of each channel is 750Ω.

For detail, see section 『 Analog Output Configuration Setting 』

1.8 COMMUNICATION FUNCTION (OPTION)

The instrument can communicate with RS232C/RS485. And also can print data by micro printer.

RS232C/RS485 Communications

RS232C or RS485 can be select when the instrument communicates with PC. By using the wired network (485 networks), radio, GPRS, Modem and other methods, connect to the computer.

The Instrument adopts the international common standards: MODBUS-RTU communication protocol.

The OPC software also provides for users, you can use it to connect the he configuration software.

Connect to the panel printer

The instrument can be connected to the panel printer.

You can print history data and history curve manually.

Print real-time data will be automatic.

1.9 OTHER FUNCTIONS

24 VDC Power Supply for Transmitter (Option)

The instrument provides 8 channels power supply of 24 VDC. The maximum current of each channel can be provided is 60mA. Because the same connection corresponds to 4-20mA current signal, measured data of the transmitter can be displayed after it after connected with the input terminals.

CHAPTER2 BEFORE USING THE INSTRUMENT

2.1 PRECAUTIONS ON THE USE OF THE INSTRUMENT

Read the following precautions before using the instrument and the external storage medium (U disk).

Handling Precautions

- Be careful when cleaning the instrument, especially any plastic parts. When cleaning, wipe with a dry, soft cloth. Do not use chemicals such as benzene or thinner, since these may cause discoloring and deformation.
- Keep electrically charged objects away from the instrument as this may cause malfunction.
- Do not apply shock to the instrument.
- If there are any symptoms of trouble such as strange odors or smoke coming from the instrument immediately turn OFF the power and unplug the power cord. Then, contact your dealer or our company.

Handling precautions of external storage media

- Handling external storage media carefully as they are delicate products.
- Please note the U disk ESD protection.
- Recommend using this company's products
- If you are using them in a high-temperature environment (greater than 40°C), we recommend the external storage medium be inserted into the drive when saving the data and be removed after the data have been saved.
- Remove the external storage medium from the drive when turning ON/OFF the instrument.
- When the store lights (in the U disk) light up, do not remove the storage media, otherwise it may destroy the data.
- For general precautions see the instruction manual that came with the external storage medium.

2.2 INSTALLING THE INSTRUMENT.

To the installing place of this instrument, the installation method will explain here. Be sure to read this section before install it.

Installation location

Install the instrument in a location that meets the following conditions.

- Instrument panel

The instrument is designed for panel mounting.

- Location of installation

To prevent rain and direct heat, install the instrument indoors.

- Well-ventilated location

To prevent overheating, install the instrument in a well-ventilated location.

- Minimum mechanical vibrations

Choose an installation location with the minimum mechanical vibration.

- Horizontal

Install the instrument horizontally (However, the instrument can be inclined up to 10 degrees backwards for panel mounting).

Note
<ul style="list-style-type: none"> ● Condensation may occur if the instrument is moved to another place where both the ambient temperature and humidity are higher, or if the temperature changes rapidly. In addition, measurement errors will result when using thermocouples. In this case, let the instrument adjust to the new environment for at least one hour before using the instrument. ● The lifetime of the LCD may be shortened (lower picture quality, etc.) if the instrument is used in a high-temperature environment over a long period of time. When installing the instrument in a high-temperature environment (greater than 40°C), please reduce the LCD brightness. For LCD brightness setting, please refer to 『screen brightness setting』

Do not install the instrument in the following places:

1. In direct sunlight or near heat sources

Install the instrument in a place with small temperature fluctuations near room temperature (23°C). Placing the instrument in direct sunlight or near heat sources can cause adverse effects on the internal circuitry.

2. Where an excessive amount of soot, steam, moisture, dust, or corrosive gases are present

Soot, steam, moisture, dust, and corrosive gases will adversely affect the instrument. Avoid such locations.

3. Near strong magnetic field sources

Do not bring magnets or instruments that produce electromagnetic fields close to the instrument. Operating the instrument in strong magnetic fields can cause errors in

the measurements.

4. Bad angle for viewing the screen

Because the instrument uses a “10.4” TFT color LCD, it is difficult to view the display from an extreme angle. Please install the instrument so that the monitor can be viewed from the front.

Installation Procedure

The instrument should be mounted on a steel panel of thickness from 2 mm to 12 mm.

1. Insert the instrument from the front side of the panel.
2. As shown in the figure below, mount the instrument to the panel using the mounting brackets that came with the package.
 - Use two brackets under the cover of the instrument
 - The screws of instrument panel mounting bracket are the standard M4 screws.

Installation diagram

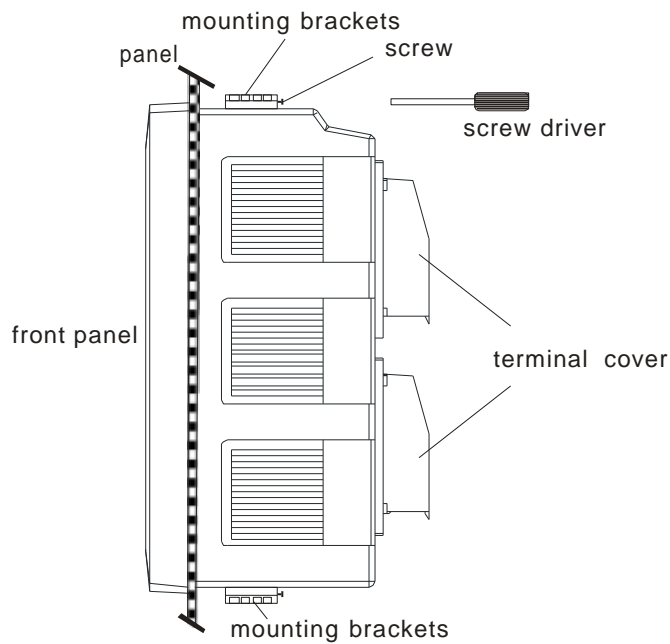

2.3 INPUT AND OUTPUT SIGNAL WIRING

Here will explain the measurement of input / output signal lines. Be sure to read this section before connecting the input and output signal wiring.

Caution

If a strong tension is applied to the cable wired to the instrument, the terminals of the instrument and the cable can be damaged. In order to prevent tension from being applied directly on the terminals, fasten all wiring cables to the rear of the mounting panel.

Precautions to be taken while wiring

Take the following precautions when wiring the input signal cables.

It is recommended that crimp-on lugs (designed for 4 mm screws) with insulation sleeves be used on the lead wire ends.



Crimp-on lugs (designed for 4 mm screws) with insulation sleeves

Take measures to prevent noise from entering the measurement circuit.

- Move the measurement circuit away from the power cable (power circuit) and ground cable.
- It is desirable that the item being measured does not generate noise. However, if this is unavoidable, isolate the measurement circuit from the item. Also, ground the item being measured.
- Shielded wires should be used to minimize noise caused by electrostatic induction. Connect the shield to the ground terminal of the instrument as necessary (make sure you are not grounding at two points).
- For the interference generated by electromagnetic induction, if splicing the equidistant dense circuit wiring, it will be more effective.
- The resistance of ground terminal is lower.

When using the thermocouple input, take measures to stabilize the temperature at the input terminal.

- Always use the input terminal cover.
- Do not use thick wires which may cause large heat dissipation (cross sectional area 0.5mm² or less recommended).
- Make sure that the ambient temperature remains reasonably stable. Large temperature fluctuations can occur if a nearby fan turns ON or OFF.

Connecting the input wires in parallel with other devices can affect measured value.

If you need to make a parallel connection, then

- Ground the instruments to the same point.
- Do not turn ON or OFF another instrument during operation. This can have adverse effects on the other instruments.
- RTD cannot be wired in parallel.
- Current signal cannot be wired in parallel.

WARNING

- To prevent electric shock, ensure the main power supply is turned OFF

CAUTION

- Do not apply input signals that exceed the following values. This can damage the instrument.

1. Maximum input voltage

Voltage range of 0.2 VDC or less or thermocouples: -1V ~ +5V

Voltage range between 2 and 10 VDC: -1V ~ +12V

Current: -4mA ~ +25mA

2. Maximum common mode noise voltage

250VACrms (50Hz)

Wiring Procedure

1. Turn OFF the instrument and remove the input terminal cover.
2. Connect the input/output signal wires to the input/output terminals.
3. Fit with the rear terminal cover and supply electricity.

Note

Remove the rear terminal cover in order to easily carry out wiring work. To prevent bad connection, after wiring please carefully tighten the screws.

The position of input / output signal terminal in the tail terminal

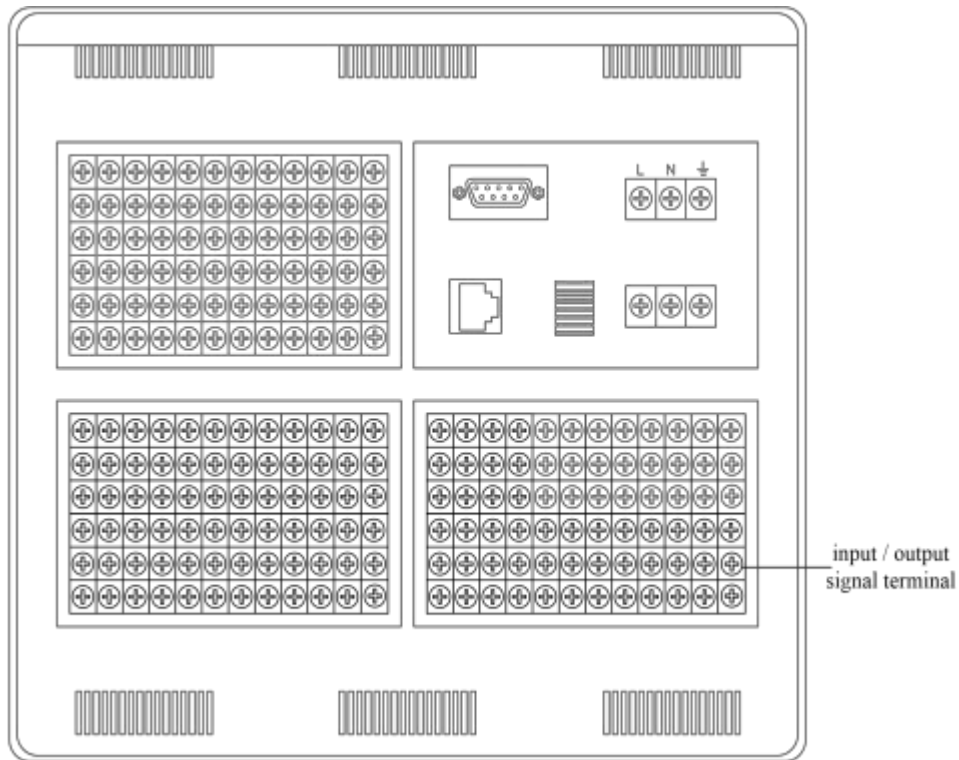

Input / output signal channel arrangement

13A	14A	15A	16A	17A	18A	19A	20A	21A	22A	23A	24A
13B	14B	15B	16B	17B	18B	19B	20B	21B	22B	23B	24B
13C	14C	15C	16C	17C	18C	19C	20C	21C	22C	23C	24C
1A	2A	3A	4A	5A	6A	7A	8A	9A	10A	11A	12A
1B	2B	3B	4B	5B	6B	7B	8B	9B	10B	11B	12B
1C	2C	3C	4C	5C	6C	7C	8C	9C	10C	11C	12C

37A	38A	39A	40A								
37B	38B	39B	40B								
37C	38C	39C	40C								
25A	26A	27A	28A	29A	30A	31A	32A	33A	34A	35A	36A
25B	26B	27B	28B	29B	30B	31B	32B	33B	34B	35B	36B
25C	26C	27C	28C	29C	30C	31C	32C	33C	34C	35C	36C

Wiring diagram

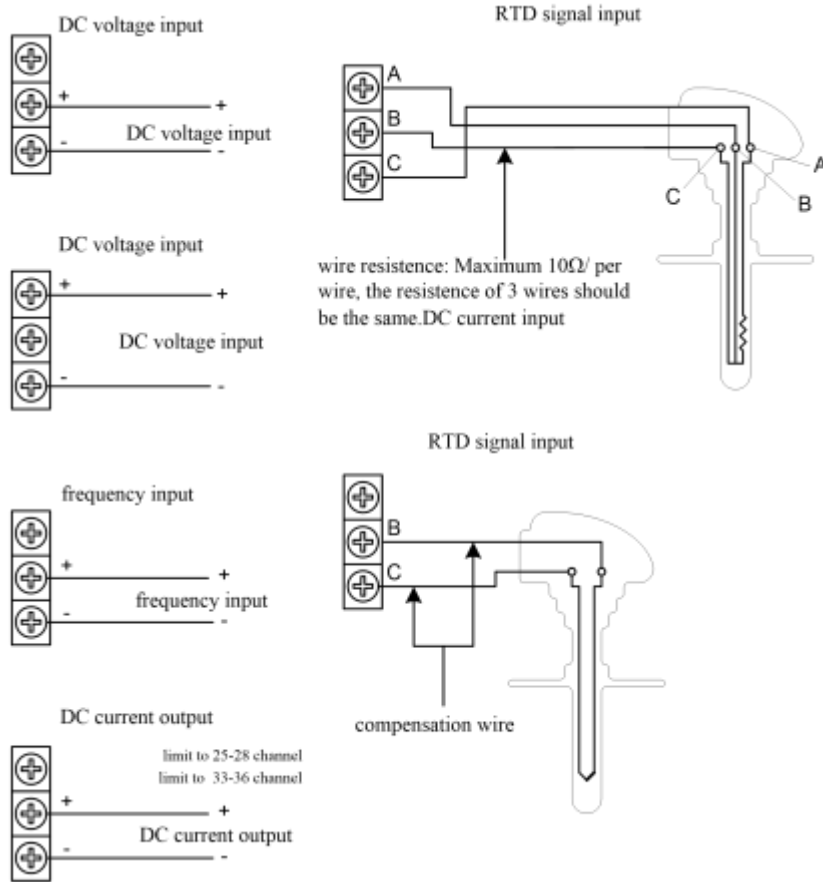

Note

Order 4-way current output, output channels 33-36 correspondingly transmit 1-4.

Order 8-way current output, output channels 25-28 transmit correspondingly 1-4, and output channels 33-36 correspondingly transmit 5-8.

2.4 ALARM OUTPUT WIRING (OPTION)

WARNING

- To prevent electric shock, ensure the main power supply is turned OFF.
 - If a voltage of more than 30 VAC or 60 VDC is to be applied to the alarm output terminal, use ring-tongue crimp-on lugs with insulation sleeves on all terminals to prevent the wires from slipping out when the screws become loose. Furthermore, use double-insulated wires (dielectric strength of 2300 VAC or more) for the signal wires on which a voltage of more than 30 VAC or 60 VDC is to be applied. For all other wires, use basic insulated wires (dielectric strength of 1350 VAC). To prevent electric shock, attach the terminal cover after wiring and make sure not to touch the terminals.
-

Wiring Procedure

1. Turn OFF the instrument and remove the cover for the rear terminal.
2. Connect the alarm output cables to the terminal.
3. Replace the terminal cover and turn the power on.

CAUTION

Remove the rear terminal cover to wire easily. In order to prevent poor contact, tighten the screws after wiring

Alarm Output Terminal Position

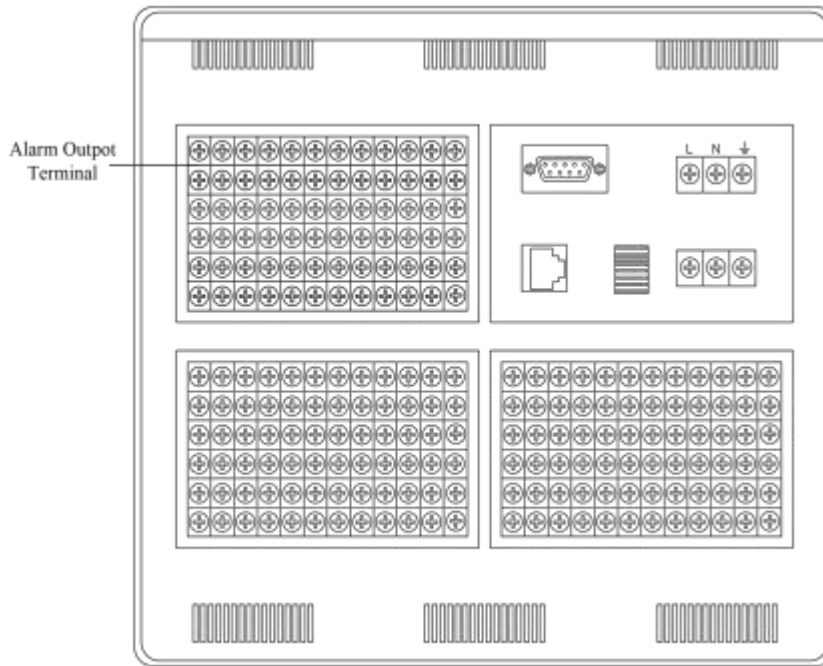

Alarm output channel arrangement

13R	14R	15R	16R	17R	18R	19R	20R	21R	22R	23R	24R
13R	14R	15R	16R	17R	18R	19R	20R	21R	22R	23R	24R
1R	2R	3R	4R	5R	6R	7R	8R	9R	10R	11R	12R
1R	2R	3R	4R	5R	6R	7R	8R	9R	10R	11R	12R

Contact specifications

Item	Content
Output	Relay transfer contact (energize/de-energize switchable)
Output capacity	250VAC/3A 30VDC/3A
Dielectric	500VAC/ one minute

2.5 INPUT DIGITAL SIGNAL WIRING (OPTION)

Here will explain the input signal wiring. Be sure to read this section before connecting the power.

Wiring Procedure

1. Turn OFF the instrument and remove the cover for the rear terminal.
2. Connect input signal line to the input terminal
3. Fit with the terminal cover and turn on the power.

CAUTION

Remove the rear terminal cover to wire easily. In order to prevent poor contact, tighten the screws after wiring

Digital Input Terminal Position on the Rear Terminal

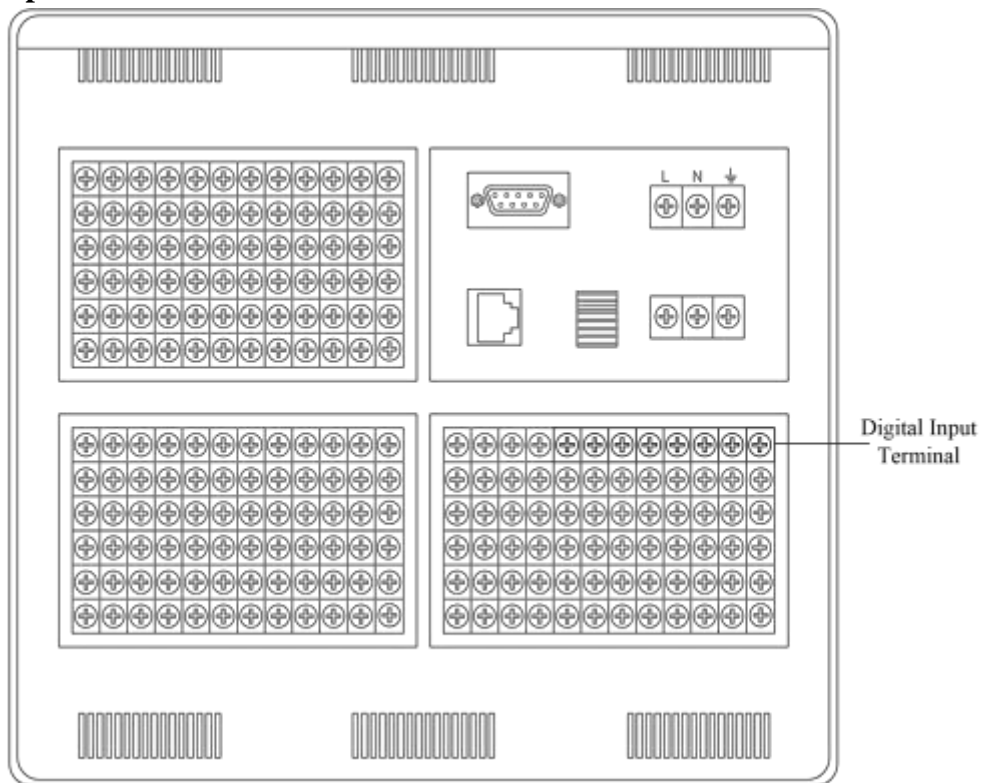

Digital Input Channel Arrangement



Contact specifications

Item	Specification
Input signal	Voltage-free (dry) contact, open-collector (TTL or transistor)
Input conditions	Signal width: above 250ms Input voltage: ON: 4VDC – 24VDC OFF: 0VDC – 1VDC
Input type	Photocoupler isolation; Internal isolation power source (24VDC±5%) (Voltage-free (dry) contact or open-collector (TTL or transistor))
Dielectric strength	30VDC for one minute between the positive side and negative side of input terminals.

2.6 CONNECT POWER SUPPLY

Here explains power wiring method. Be sure to read this part before connecting power.

Precautions to be taken when wiring the power supply

To prevent electric shock and damage to the instrument, observe the following warnings.

WARNING

- To prevent electric shock, ensure the main power supply is turned OFF.
- To prevent fire, use doubled-insulated wire
- Make sure to earth ground the protective earth terminal through a grounding resistance less than 100Ω before turning ON the power.
- Use crimp-on lugs (designed for 4mm screws) for power and ground wiring termination.
- Make sure to provide a power switch (double-pole type) on the power supply line in order to separate the instrument from the main power supply. Put an indication on this switch as the breaker on the power supply line for the instrument.

Switch Specification Rated current: 3A or more

- Connect a fuse (between 2A and 15A) to the power line.
-

Wiring Procedure

- 1.Connect the power supply wires and the protective ground wire to the power terminals.
2. Turn on the power.

The position of power terminal in the rear terminal

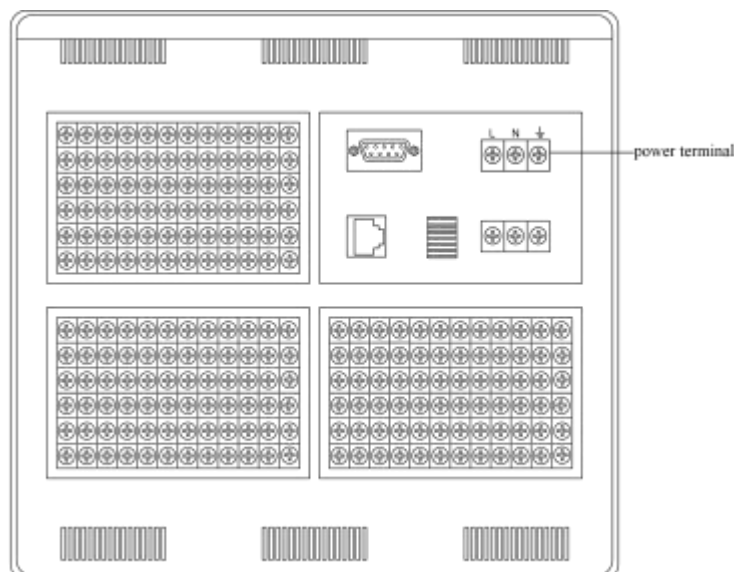

Terminal Arrangement

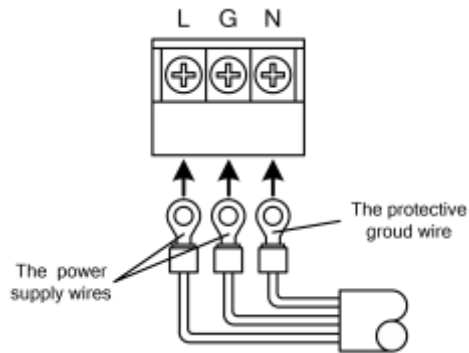

Contact specifications

Item	Specification
Input voltage	85VAC ~ 265VAC
Input frequency	50Hz

2.7 24VDC TRANSMITTER POWER WIRING (OPTION)

Transmitter power output

CAUTION

- Never short-circuit the power supply terminals or apply an external voltage, otherwise damage to the instrument may result.

Wiring Procedure

1. Turn OFF the instrument and remove the cover of the rear terminal.
2. Connect the power line of transmitter to the output terminal.
3. Fit with the terminal cover and turn on the power.

Note

- Remove the cover for the option terminal can be expediently to wiring. To prevent contact badness, fasten it with screws after wiring.

The position of transmitter power output terminal in the rear terminal

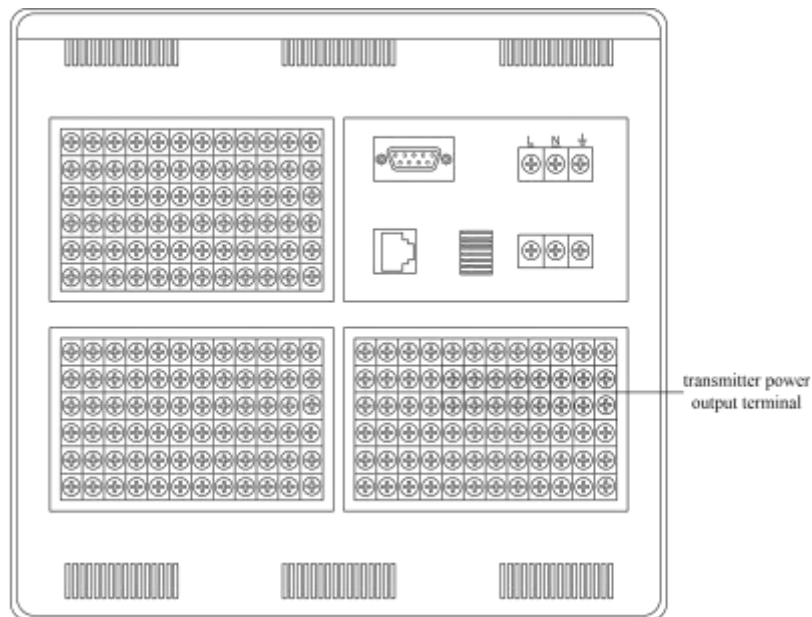

Output channel arrangement of transmitter power

1P+	2P+	3P+	4P+	5P+	6P+	7P+	8P+
1P-	2P-	3P-	4P-	5P-	6P-	7P-	8P-

Wiring Diagram

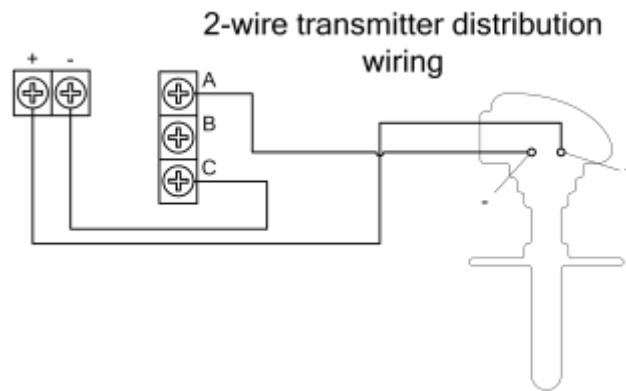

24VDC Transmitter Power Supply

- Loop: 8
- Output voltage: 22VDC ~ 25VDC (rate output current)
- Maximum output current: 65mADC (over-loading protect current: about 90mADC)
- Allowed resistance: $RL \leq (17 - \text{minimum circulate voltage}) / 0.02A$
- There into: $RL \leq 750\Omega$
- 17V = 22V - 5V
- 22V: Minimum output voltage
- 5V: Maximum voltage drop (shunt resistance 250Ω)

2.8 RS232C/RS485 COMMUNICATION WIRING (OPTION)

Here explains RS232C/RS485 communication wiring. Be sure to read this part before connecting.

Wiring Procedure

RS232C/RS485 Communication interface position in the rear instrument.

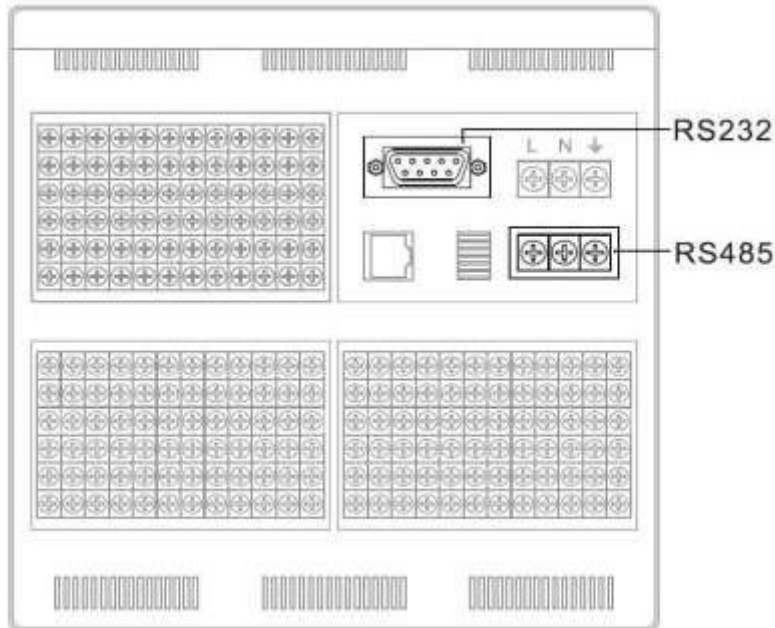

RS232C connection

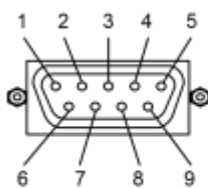

Pin number	Signal Name	Description
2	RXD	Receive data from the RS232 interface, and the instrument input signal
3	TXD	Send data to the RS232 interface, and the instrument output signal
5	GND	Signal Ground

Signal direction



RS485connection

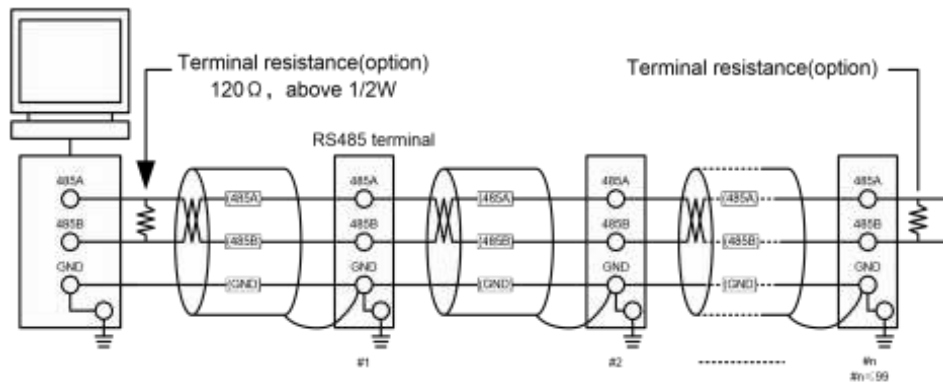
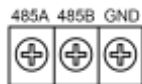

Don't connect terminal resistance between #1 and #n-1

Communication Specifications

Item	Content
Speed(baud rate)	1200/2400/4800/9600/19200/38400/57600
Data format	Eight data bits, One stop bit Optional checkout code (None/odd/even)

CHAPTER3 NAMES OF PARTS/RUN

MODE/COMMON OPERATIONS

3.1 NAMES OF PARTS AND FUNCTIONS

Front Panel

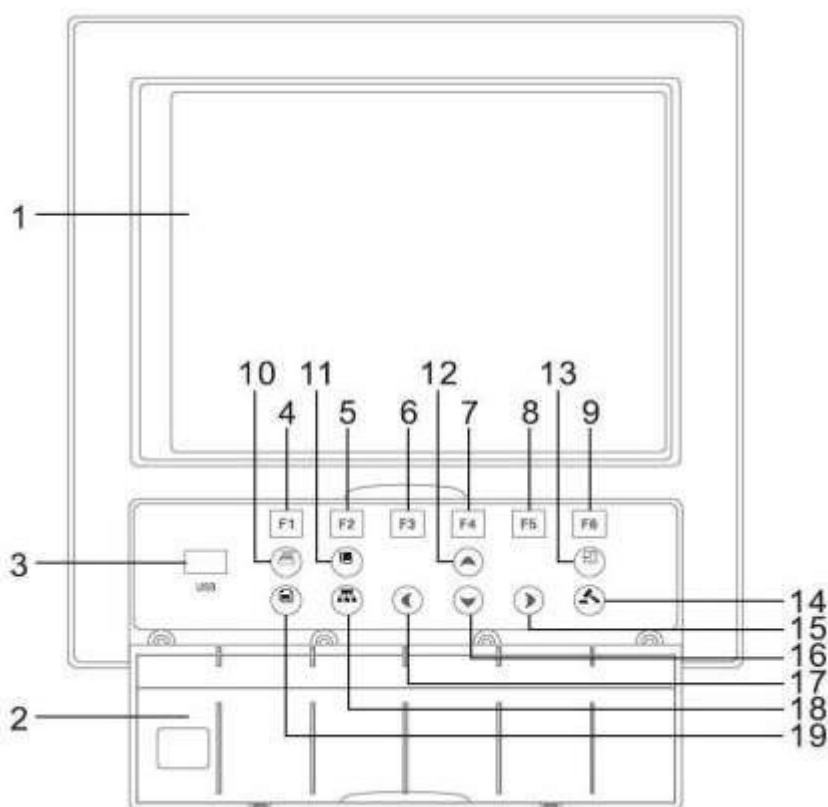

1. LCD Screen

Display various operation screens such as the trend display and the setup screen to configure the instrument.

2. Front Cover

Open this cover to access the keys or inserting or removing the external storage medium such as the USB disk. Open the cover by catching the center of the top edge of the cover and pulling it toward you. Keep the cover closed at all times except when accessing the keys and the external storage medium.

3. USB port

USB port, insert the U disk to backup data for use.

4~9 : Functional key F1~F6

Functional key F1 ~ F6, each page has its own special features, which have been marked in the screen below.

10. PRINT key

Enter the data print screen.

11. RECORD Key

There has been no definition of this key so far.

12. UP key

Used to increase the value that cursor indicated.

13 EXIT key

Used to exit the screen

14. ENTER key

Used to execute the function of button that cursor indicated.

15. RIGHT key

Used to move cursor to right

16. DOWN key

Used to decrease the value that cursor indicated.

17. LEFT key

Used to move cursor to the left

18. CONFIGURATION key

Used to enter the configuration screen.

19. BACKUP key

Used to enter the data backup screen.

Rear Panel

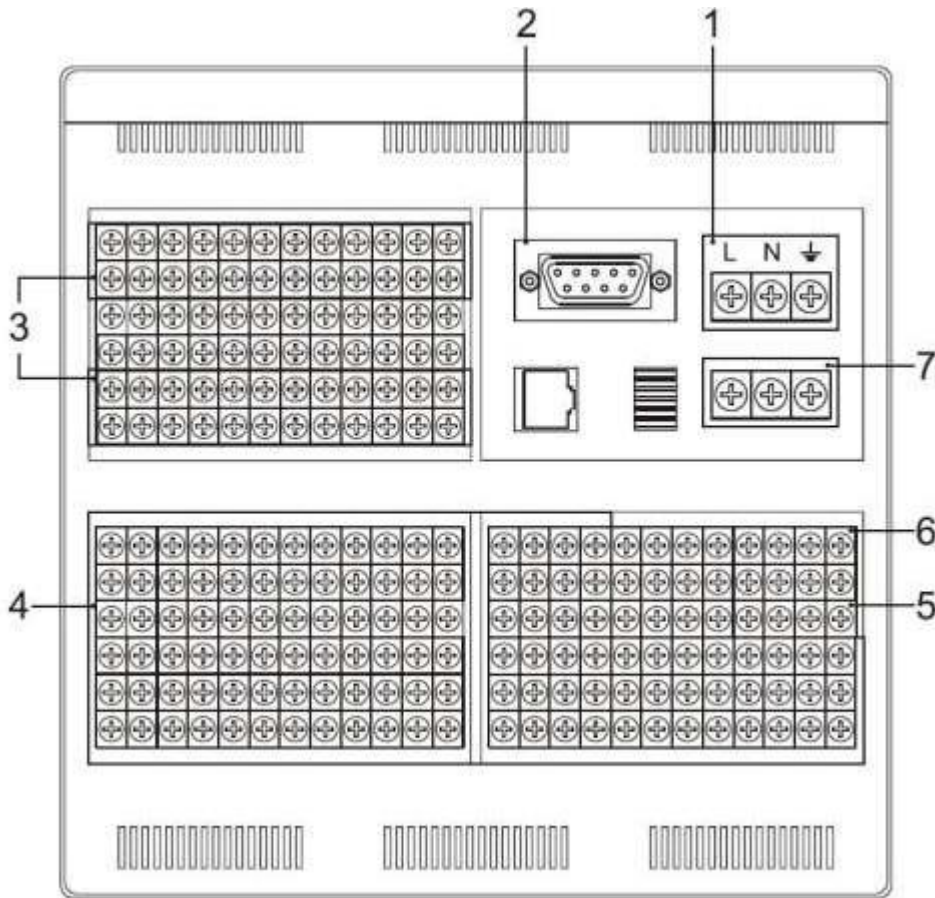

1. Power terminals

Connect the power cord and ground protective line.

2. RS232 Port

RS-232 port is used to connect the interface cable.

3. Alarm output terminal

Connect relay alarm output signal line.

4. I/O signal terminals

Connect the input signal cable of the item being measured or output signal cable of analog current.

5. 24 VDC Power Supply for Transmitter

Provide 24 VDC power line to sensor.

6. Digital input terminals

Connect the input digital signal cable.

7. RS485 Interface

RS485 interface for connecting communication cables.

3.2 INSERTING/REMOVING THE EXTERNAL STORAGE MEDIUM

This section describes the procedures to insert and remove the external storage medium.

USB disk is the only type of media can be used.

For the handling procedure of the storage medium, see section 『back up history data』 .

Procedure

Inserting the storage medium

1. Open the front cover. Insert the U disk into the USB port.
2. The instrument detects the U disk in the drive automatically.
3. Enter Backup screen, and prepare to back up data. Success information will be displayed when backup ended.
4. back up data

CAUTION

- Keep the front cover closed during operation except when accessing the external storage medium. This will protect the storage medium and the drive from particles such as dust.
- Keep the metal face upper when inserting the U disk, otherwise the U disk can't be inserted.
- If you are using a commercially available U disk, be careful of static electricity.
- It is recommended using our company's products.

Remove the storage media

1. make sure there is no data saved in storage media

Caution

- The access lamp is lit while the storage medium is being accessed.
- A message “Data are being saved to the medium.” is displayed while data are being saved to the medium.

Description

Formatting external storage media

Use the external storage medium which has been formatted.

Please use the PC to carry on the formatting for the USB flash drives (FAT32), because this product doesn't provide the formatted function.

Specification

Item	Content
USB port	Support the USB 2.0 protocol
U disk capacity	The maximum capacity is 1GB

3.3 RUN MODE

There are two run modes: operating and setting. This section describes the functions and relationships of the two modes.

Mode Types

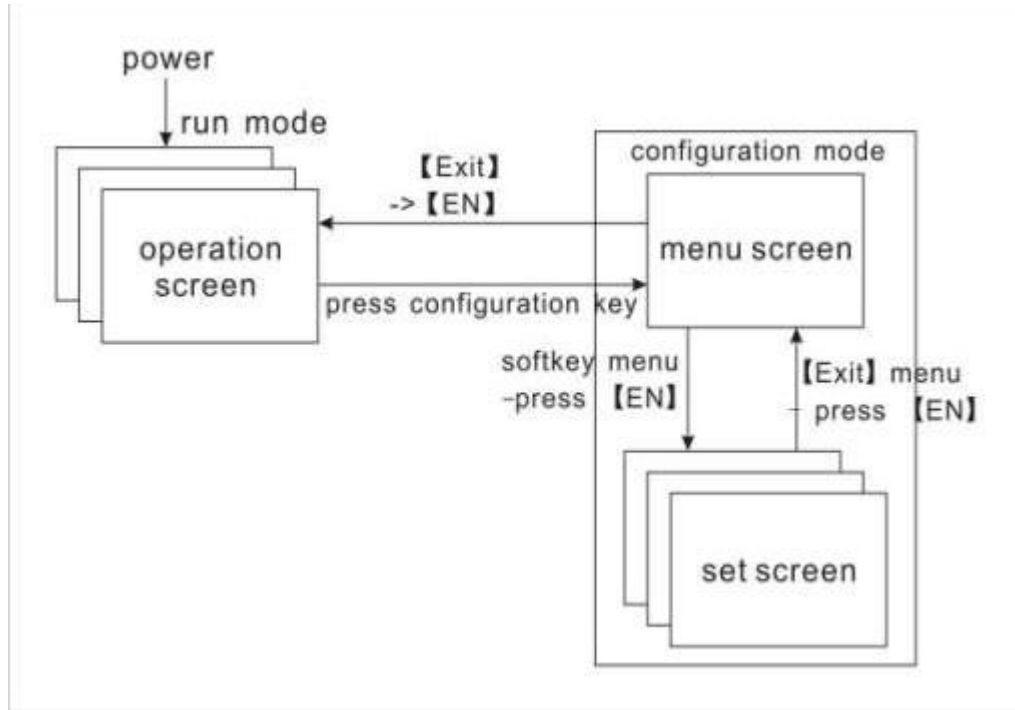

Mode Type	Content	Possible operations
Operation Mode	This mode is used for daily operation. This mode is entered when the power is turned ON.	<ul style="list-style-type: none"> •Display measured /operated data •Data acquisition •Data printing
Setting mode	This mode is used to configure the operation such as input range, input type, data storage type, alarms, etc. This mode is entered by pressing the configuration key at the setting mode menu. Measured / operated data can't be displayed in this mode. Operations such as measurements, alarm	<ul style="list-style-type: none"> •Set a variety of configuration parameters •Operations related to the files in external storage media

detection, and data
 acquisition are continued.
 Back up data to external
 storage media

Functions and Operations of the Operation Mode

Switching the operation screen

Display various operation screens such as digital display, bar graph, trend, historical trend, alarm summary, etc.

Screens are switched by the [Page] key. See section 『switch operation screens』 .

The operation screen with different key operating has the different functions. The concrete pressed key operation and the function please see section 『 operation of operation screen』 .

Functions and operation of setting modes

Use arrow keys and [En] key to set the instrument's functions.

Please refer to 『set functions』 , for the setting method, see 『chapter 5～ chapter 12』 .

3.4 CONFIGURING THE FUNCTIONS

Setting Mode

The configuration mode is used to set the various parameters of the running system.

CAUTION

- Change some system parameters will affect the data acquisition. We suggest backing up data before changing system parameters.

Setting Items

User can carry out the following content in configuration mode:

- Set System Configurations
- Setting Signal Inputs
- Setting Alarms
- Setting Analog Outputs
- Setting storage and backup
- Setting Communication Function
- Initializing Data

3.5 COMMON KEY OPERATIONS

This section describes common key operations which are often used.

Key operations in the setting mode

Entering the setting mode

1. Enter the running mode directly after power on
2. Select [Exit] to enter the setting mode in the configuration mode.

Key operations in the configuration mode

Entering the setting mode

1. Under the setting mode, Press [Page] and [En] to enter the configuration screen.
2. Move the cursor and press the [En] to enter each configuration screen.
3. Move the cursor and press [En] to enter all the configuration screens.

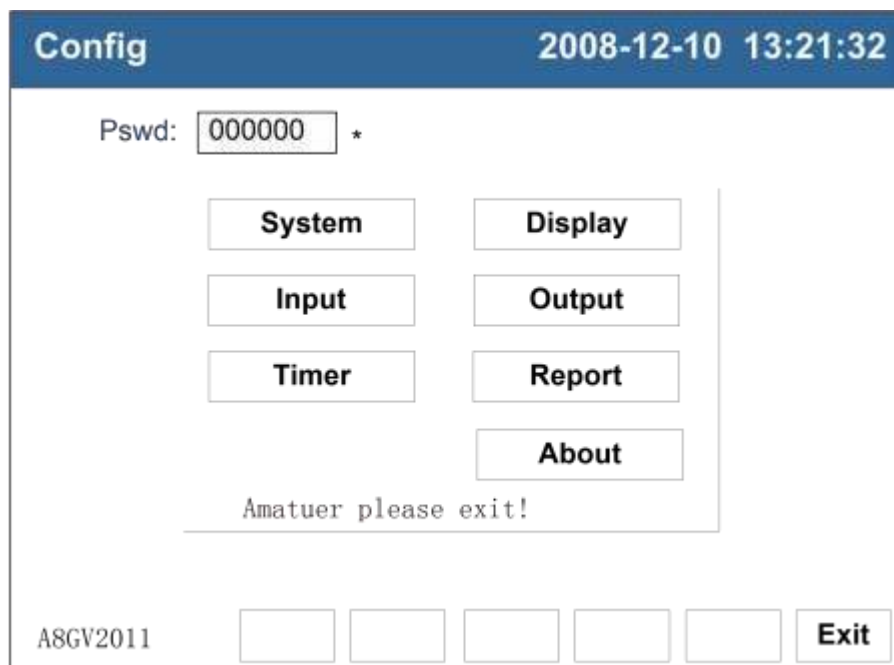

Selecting the item

Used [Left] and [Right] to move the cursor (blue) to the appropriate item or operation key.

Confirming operation

Press [En] to confirm the settings.

Modifying the parameter

There are two types of the revisable parameters, select input parameter and edit input parameter.

- Selecting input parameter (The right side of the item has a ◆ sign)

Used [Up] and [Down] to move the cursor to modify the appropriate parameter.

- Editing input parameter (The right side of the item has no sign)

When the parameter can be edited, user can input Number, English (Caps), English, Special Symbol.

Move the cursor to the edited parameter, press [En] and there will be an input panel, user can operate on it.

Input Number/English (Caps)/English/Special Symbol

Used in inputting range, unit, etc.

● **Direct Input Method**

Directly use the "arrow keys" to adjust the default parameters.

Enter numbers



Enter the number "4.00":

- 1, press [F5], delete the original contents in the input display field;
- 2, press [F1] to select 1234;
- 3, press [Left] [Right], move the cursor to select the number "4";
- 4, press [F6], display "4" in the input display column;
- 5, press [left] [Right], move the cursor to select the ".";
- 6, press [F6] display "4." in the input display column;
- 7, press [left] [Right], move the cursor to select "0";
- 8, press [F6], display "4.0" in the input display column ;
- 9, press [F6], display "4.00" in the input display column ;
- 10, press [En], confirm enter, exit the input menu.

Enter capital English letters



Enter capital letter "A":

- 1, press [F5], delete the original contents in the input display field;
- 2, press [F1] to select ABCD;
- 3, press [left] [Right], move the cursor to select the letter "A";
- 4, press [F6], display "A" in the input display column;
- 5, press [En], confirm input, then exit the input menu.

Enter lower case letters



Enter lowercase letter "a";

- 1, press [F5], delete the original contents in the input display field;
- 2, press [F1] to select **abcd**;
- 3, press [left] [Right], move the cursor to select the letter "a";
- 4, press [F6], display "a" in the input display column ;
- 5, press [En], confirm input, exit the input menu. ;

Enter special symbols



Enter the special symbol "#":

- 1, press [F5], delete the original contents in the input display field;
- 2, press [F1] to select **#*\$@** ;
- 3, press [left] [Right], move the cursor to select the letter "#";
- 4, press [F6], display "#" in the input display column;
- 5, press [En], confirm input , then exit the input menu;

CHAPTER 4 SWITCHING OPERATION SCREENS

4.1 SWITCHING OPERATION SCREENS

This chapter describes the screen (operation screen) used to display the measured / computed data.

The operation screens are composed of digital display, bar, real-time trend, history trend, alarm summary, accumulative report (option).

Use the [F1] key to switch each screen.

In the operation screen, press [backup] key to enter the backup screen, press the [Print] to enter print screen, press the [configuration] to enter the configuration screen.

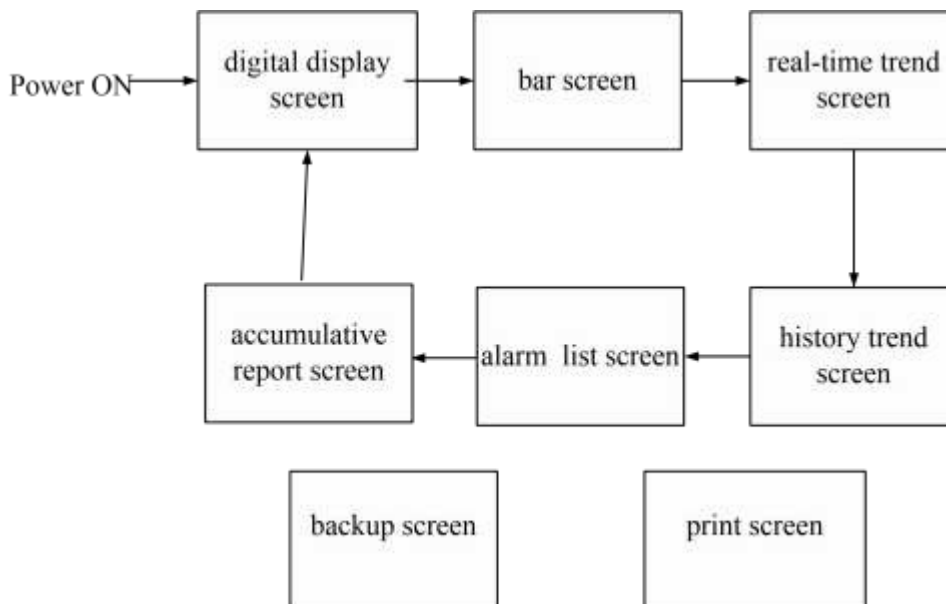

4.2 EXPLANATION OF THE STATUS DISPLAY SECTION

When in operation mode or configuration mode, display the following information in the status display section.



1.Screen name

Display name, display [device name] when display full channel digital screen.

2..USB device status

USB icon: have connections between a USB device and instrument.

No show: no USB devices connection with the instrument.

3.Circular display symbol (real-time screen)

Circular display symbol: Circularly display all groups

No display: Fixed screen, having no circular display

4. Current date and time

The current date and time of the instrument

4.3 DIGITAL DISPLAY SCREEN

The large digital display measured / computed data. On the way of display, please refer to the section 『switch operation screen』 .

Value			2010-06-20 10:08:20		
Chnl01	38.24 %		Chnl02	38.24 %	
Chnl04	38.24 %		Chnl05	38.24 %	
Chnl07	38.24 %		Chnl08	38.24 %	
Chnl10	38.24 %		Chnl01	38.24 %	
Chnl13	38.24 %		Chnl14	38.24 %	
Chnl16	38.24 %		Chnl17	38.24 %	
Chnl19	38.24 %		Chnl20	38.24 %	
Chnl22	38.24 %		Chnl23	38.24 %	
			Chnl03	38.24 %	
			Chnl06	38.24 %	
			Chnl09	38.24 %	
			Chnl12	38.24 %	
			Chnl15	38.24 %	
			Chnl18	38.24 %	
			Chnl21	38.24 %	
			Chnl24	38.24 %	

Page

- 1.Channel name, can be set. On the setting methods, see 『set channel tag and unit』 .
- 2.Measurement of channel /computed data

Note:

- Measure the channel’s data display

When measuring data of measurement channel anomalies (see below), the screen shows measurements for #####

- Data exception

4-20 mA: signal bellows 2 mA.

Thermocouple: The thermocouple burnout, and the [burnout set] displays an error flag.

- 3.Channel unit can be set. With regard to setting method, see section 『 Channel Tag and Channel Unit Setting』

- 4.Warning signs. From the top to bottom are high high alarm / high alarm/ low alarm / low low alarm, green is normal, red is alarm.

5. Channel cursor

Operation

Pop up multi channel digital display.

Press [up], [down] [left] [right] keys to move the channel cursor, press [En] to enter larger display screen, press the [exit] to return. Please refer to the section 『larger display screen』

4.3.1 LARGER DISPLAY SCREEN

Use a multi channel digital display, bar graph to show the measured / commutated data of a channel.

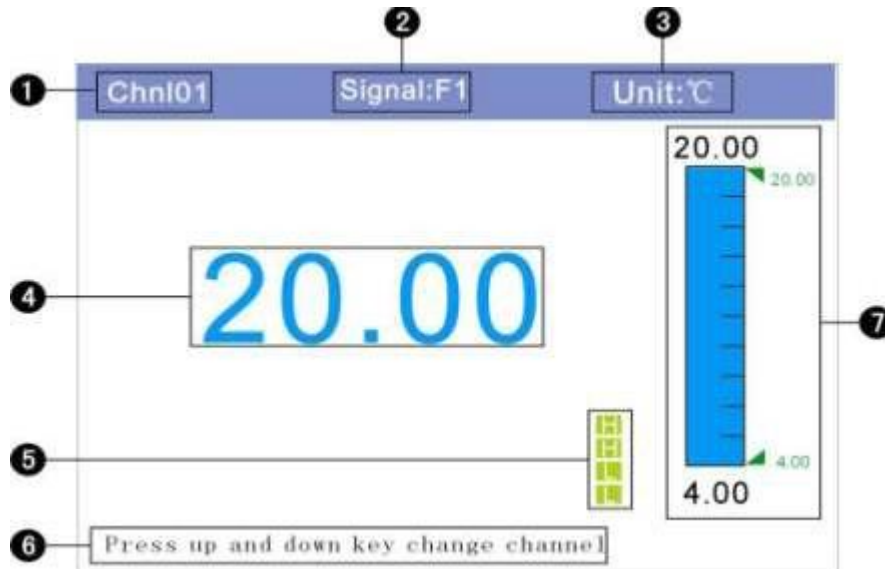

1. Channel name, can be set. On the setting methods, see 『set channel tag and units 』 .
2. Channel type, can be set. On the setting methods, see 『 set channel type and range』 .
3. Channel units, can be set. On the setting methods, see 『set channel tag and units 』 .
4. Measurement of channel /computed data.

Note:

●**Measure the channel's data display**

When measuring data of measurement channel anomalies (see below), the screen shows measurements for #####

●**Data exception**

4-20 mA: signal bellows 2 mA.

Thermocouple: The thermocouple burnout, and the [burnout set] displays an error flag.

5. Warning signs. From the top to bottom are high high alarm / high alarm/ low alarm / low low alarm, green is normal, red is alarm.

6. Indication signs.

7. Bar graph display.

Operation

Quit

press [Exit] to exit the larger screen display screen.

Channel switch

Press the [Up] key to switch to the next channel, press [Down] key to switch to the last channel.

4.4 BAR GRAPH DISPLAY

Bar graph displays the measured / operated data.

On the way to show, please refer to 『switch the operation screen』



1. Channel name, can be set. On the setting methods, see 『set channel tag and units』 .

2. Bar. Bar chart ruler has the length of 5 grids, and the length of filling color represents proportion in percent.

3. Measurement of channel /computed data.

Note:

- Measure the channel's data display

When measuring data of measurement channel anomalies (see below), the screen shows measurements for #####

- Data exception

4-20 mA: signal bellows 2 mA.

Thermocouple: The thermocouple burnout, and the [burnout set] displays an error flag.

4. Channel cursor.

Operation:

Pop-up larger digital display.

Press [up], [down] [left] [right] keys to move the channel cursor, press [En] to enter larger display screen, press the [exit] to return. Please refer to the section 『larger display screen』 .

4.5 REAL-TIME TREND SCREEN

The waveform displays measured / operated data.
 On the way to show, please refer to 『switch the operation screen』

An example of Real-time curve display (vertical)

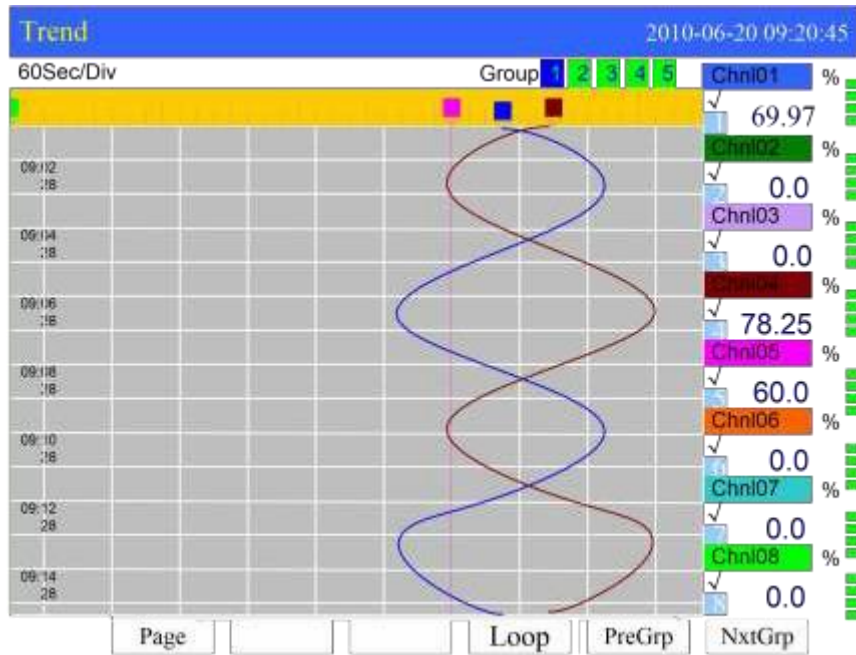

An example of Real-time curve display (horizontal)

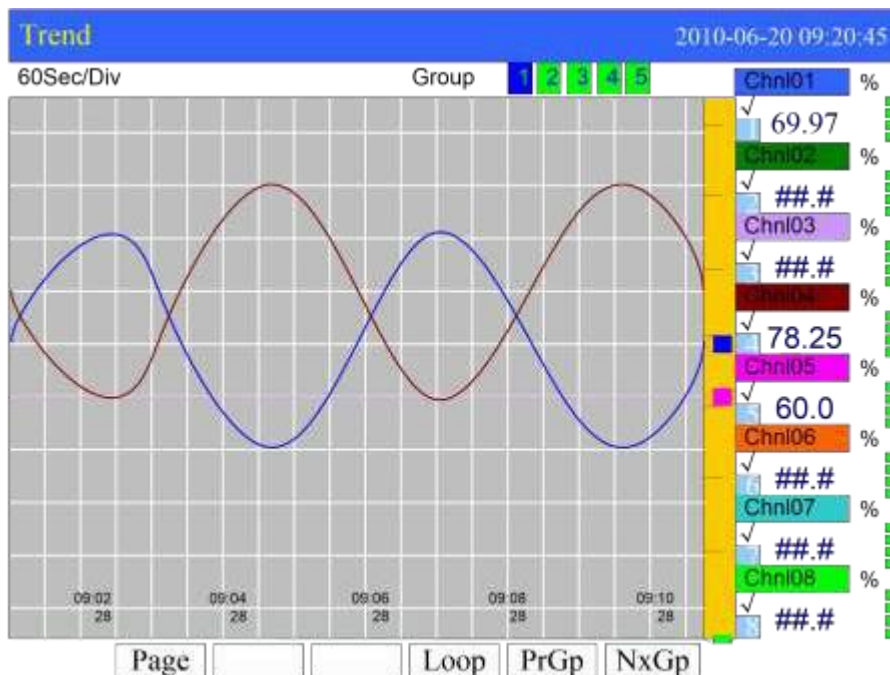

1. Trend cycle. Each grid means the length. The cycle is related with recording interval, each grid time length = recording interval × 30.
2. Data trend. Display up to 8 trends at the same screen. It can set the color of trend. With regard to setting method, please refer to 『trend direction and combination setting』
3. Grid, used to estimate the time and data value.
4. Time of the current grid.
5. Trend combination. Show the current trend combination name, can be set.
6. Scale. Display the percentage of the trend.
7. Current value mark. Display the position of the current value on the scale.
8. Channel name, can be set. On the setting methods, refer to 『set channel tag and units』. Background color and the corresponding color of the channel trend should be same.
9. Measured / computed data of channels

Note

- Measure the channel's data display

When measuring data of measurement channel anomalies (see below), the screen shows measurements for#####.

- Data exception

4-20 mA : signal bellows 2 mA.

When the thermocouple burnout, the [burnout set] displays an error flag

10. Alarm mark. From the top to the bottom, it is high high alarm, high alarm, low alarm, and low low alarm. Green is normal, and red is alarm.
11. Channel unit, can be set. With regard to setting method, see section 『Channel Tag and Unit Setting』
12. Trend sequence
13. Trend show / hide mark. "√" display trend, "×" hide trend.

Curve refresh:

Every pixel in the timeline of LCD screen represents a record of each interval.

Each interval in the curve moves once.

.

Curve cycle

When the display function is enabled, switch to display trend in the next channel every 5 seconds.

Operation

With regard to trend direction and combination, please refer to the section 『trend direction and combination setting』

Switching trend display and combinations

Press [F5], switch to the previous valid trend display combination.

Press [F6], switch to the latter valid trend display combination.

Circular display of trends

Use [F4] to open or close the circular display function. If the function is enabled, there is a mark in the status display column. Please refer to the section 『status display column』

Show or hide a trend

Use the [Left] [Right] to move the cursor, select the channel which needs to display or hide the trend, press [En] to hide or show the trend.

4.6 HISTORY TREND SCREEN

Display the measured / operated data stored in the memory with historical curve. Historical Curves show no alarm.

On the way to show, please refer to 『switch the operation screen』

Vertical history curve

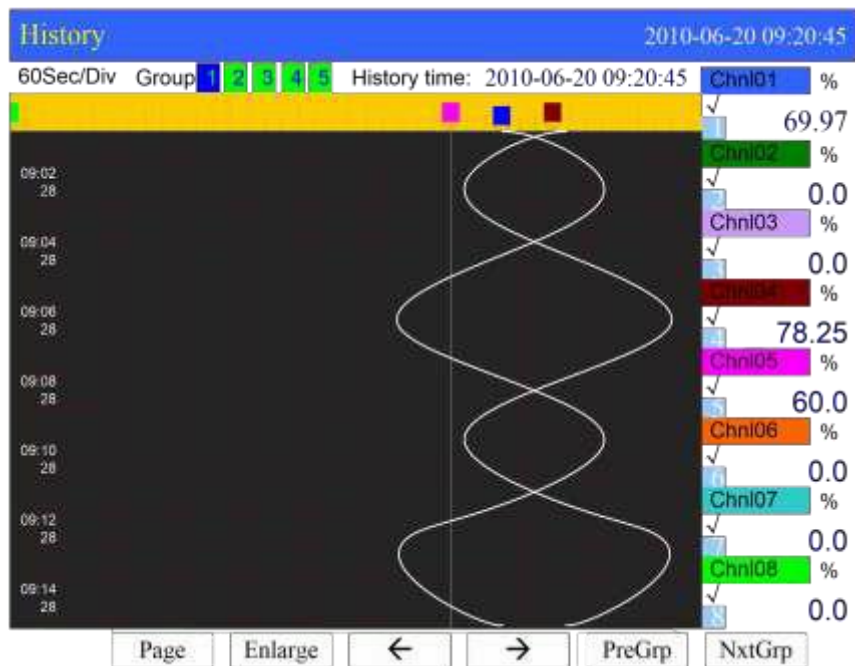

Horizontal history curve

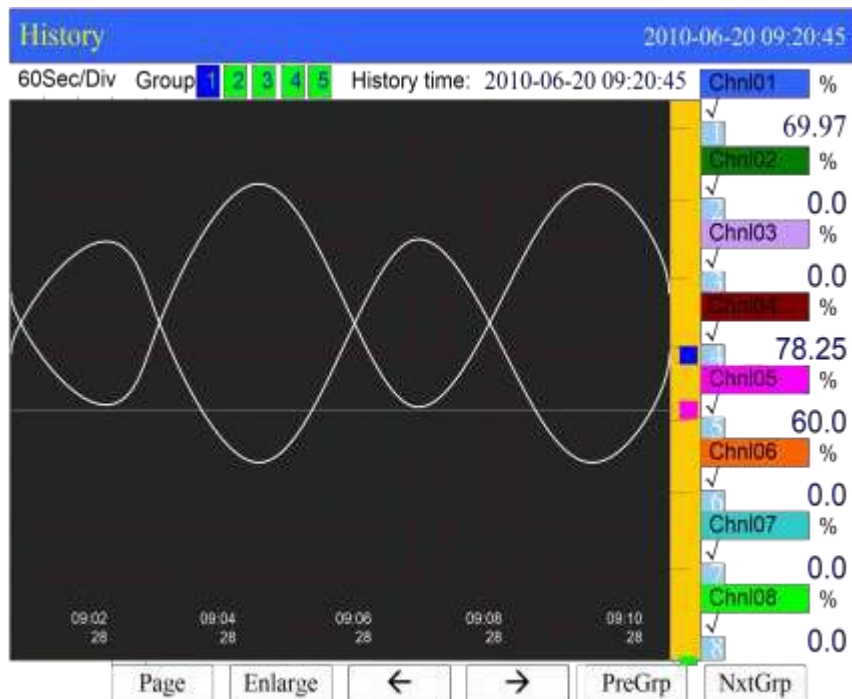

1. Trend cycle. Each grid means the length.
Time length = recording interval × Zoom multiple × 30.
2. Data trend. Display up to 4 trends at the same screen. It can set the color of trend. With regard to setting method, please refer to 『trend direction and combination setting』
3. Grid. Estimate the time and data value.
4. Cursor time. The point where the current cursor indicates.
5. Trend combination. Show the current curve combination name.
6. Scale. Display the percentage the trend.
7. Current value mark. Display the position of the current value on the scale.
8. Channel tag, can be set. With regard to setting method, See section 『Channel Tag and Unit Setting』. Background color and this corresponding trend color are identical.
9. Historical data of channels. Show the data of channels that the Meter recorded.
10. Channel unit can be set. With regard to setting method, see section 『Channel Tag and Unit Setting』
11. Trend sequence
12. Trend display symbol. “√” display, “×” hide.
13. Searching cursor. Display the trend position of searching time.

Operations:

On the trend direction, please refer to 『trend direction and combination setting』

Trend zoom

Press [F2] to switch the trend zoom times, circulation switch between 1 times/ 2 times/ 4 times/ 8 times/ 16 times/ 32 times.

Continuous state

Within this state, uses [F3] to search forward, and press [F4] to search afterward.

Fixed point state

Uses [Left] and [Right] to move cursor. Set the data and time to a desired point by using [Up] and [Down]. Press [En], the trend will be moved to the fixed point automatically.

Show or hide a trend

Uses [Left] and [Right] to move cursor, and select the channel which needs to display or hide the trend, press [En] to hide or show the trend.

4.7 ALARM SUMMARY

Display the latest channel alarm information. It can display up to 17 pieces alarm information every page, and display a total number of 187 alarm information.

On the way to display, please see the section 『switching the running screen』

Alarm Summary				2010-06-21 15:04:23			
Channel	Start	End	Type				
Chnl01	2008-12-09 10:12:35	2008-12-09 10:13:25	HH				
Chnl02	2008-12-09 10:12:39	2008-12-09 10:13:29	LL				
Chnl03	2008-12-09 10:14:35	2008-12-09 10:15:25	HH				
Chnl04	2008-12-09 10:16:35	2008-12-09 10:18:25	HH				
R01	R02	R03	R04	R05	R06	R07	R08
R09	R10	R11	R12	R13	R14	R15	R16
Page:10/10		Page				PgUp	PgDw

1. Channel. This column is used to display the channel which generates alarm information.
- 2.Channel sequence number. Display the signal channel number which has the current alarm information.
3. Channel name, can be set. On the setting methods, please refer to 『set channel tag and units 』 .
4. Alarm time. This column is used to display the alarm time.
5. Cancellation time. This column is used to display the cancellation time.
6. Alarm type. Display the alarm type.
7. Current alarm time. Display alarm information generated at this time.
8. Current cancellation time. Display alarm status eliminated at this time.
9. Current alarm type. Display the current alarm type.
10. Relay status. Display the current output state of 24 relays.

Relay Type	Normally Open	Normally closed
Green	open	close
Red	close	open

Operation

Press [F5], switch to the previous page to alarm, then press [F6], switch to the next page to alarm.

4.8 REPORT

There are four types of accumulative report (Hourly, 8Hourly, 12Hourly, Daily and Monthly)

With regard to display method, please refer to section 『switch the operation screen』

(1) ACCUMULATIVE REPORT---HOURLY REPORT SCREEN

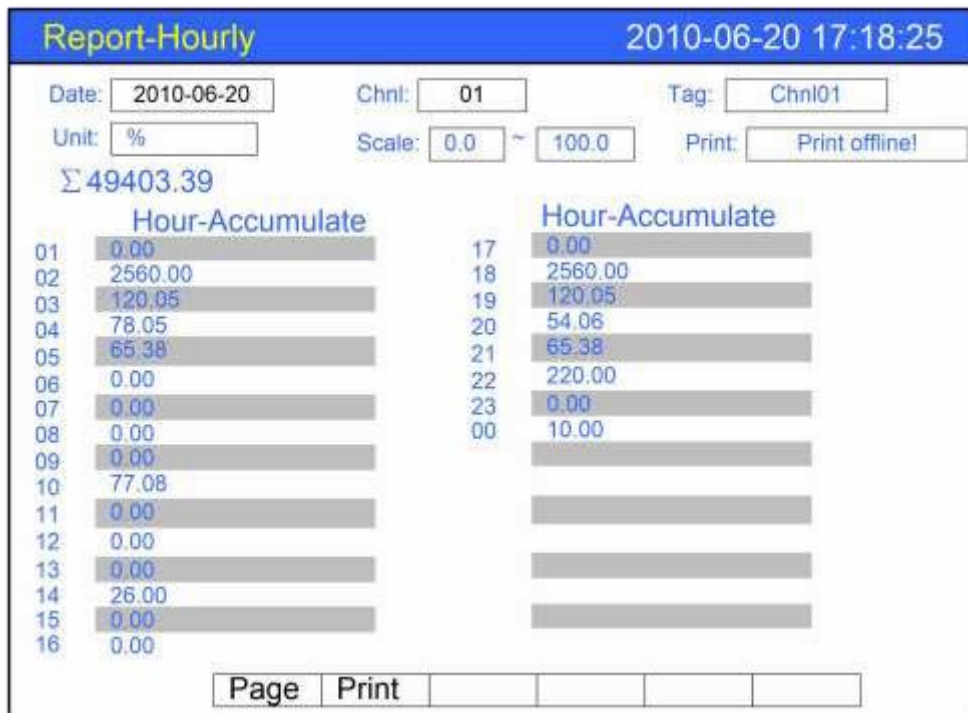

1. Query

Setting the date for query report, use [Left] or [Right] key to move the cursor, Press [Up] or [Down] key to configure the time and channel .Press [En] to query data. The report displays 24 hours' accumulation values on the screen.

2. Channel information

Display the channel's tag, units, range and other information.

3. Printer status

Display the printer is connected or not.

4. The total accumulated value

Display the total accumulative value of the channel.

5. Hours accumulative value

Display accumulative value per hour.

6. Print

If the printer is online, press [F2] key to print the accumulative report on the print screen.

(2) ACCUMULATIVE REPORT---8 HOURLY SHIFT REPORT SCREEN

Report-8 Hourly			2010-06-20 17:18:25			
Date:	<input type="text" value="2010-01"/>	Chnl:	<input type="text" value="01"/>	Tag:	<input type="text" value="Chnl01"/>	
Unit:	<input type="text" value="%"/>	Scale:	<input type="text" value="0.0"/> ~ <input type="text" value="100.0"/>	Print:	<input type="text" value="Print offline"/>	
Σ 49403.39						
	00-08	08-16	16-00	00-08	08-16	16-00
01-01	0.00	0.00	0.00	01-17	0.00	0.00
01-02	256.00	256.00	256.00	01-18	256.00	256.00
01-03	120.05	120.05	120.05	01-19	120.05	120.05
01-04	78.05	78.05	78.05	01-20	54.06	54.06
01-05	65.38	65.38	65.38	01-21	65.38	65.38
01-06	0.00	0.00	0.00	01-22	220.00	220.00
01-07	0.00	0.00	0.00	01-23	0.00	0.00
01-08	0.00	0.00	0.00	01-24	10.00	10.00
01-09	0.00	0.00	0.00	01-25	0.00	0.00
01-10	77.08	77.08	77.08	01-26	0.00	0.00
01-11	0.00	0.00	0.00	01-27	0.00	0.00
01-12	0.00	0.00	0.00	01-28	0.00	0.00
01-13	0.00	0.00	0.00	01-29	0.00	0.00
01-14	26.00	26.00	26.00	01-30	0.00	0.00
01-15	0.00	0.00	0.00	01-31	0.00	0.00
01-16	0.00	0.00	0.00			
Page			Print			

1. Query

Setting the date for query report, use [Left] or [Right] key to move the cursor, Press [Up] or [Down] key to configure the time and channel .Press [En] to query data. The report displays 8 hours' accumulation values on the screen.

2. Channel information

Display the channel's tag, units, range and other information.

3. Printer status

Display the printer is connected or not.

4. The total accumulated value

Display the total accumulative value of the channel.

5. 8-Hour accumulative value

Display accumulative value per 8 hours.

6. Print

If the printer is online, press [F2] key to print the accumulative report on the print screen.

(3) ACCUMULATIVE REPORT---12 HOURLY SHIFT REPORT SCREEN

Report-12 Hourly		2010-06-20 17:18:25							
Date:	2010-01	Chnl:	01						
Unit:	%	Tag:	Chnl01						
		Scale:	0.0 ~ 100.0						
		Print:	Print offline						
Σ 49403.39									
	00-12	12-00							
01-01	0.00	0.00	01-17 0.00 0.00						
01-02	256.00	256.00	01-18 256.00 256.00						
01-03	120.05	120.05	01-19 120.05 120.05						
01-04	78.05	78.05	01-20 54.06 54.06						
01-05	65.38	65.38	01-21 65.38 65.38						
01-06	0.00	0.00	01-22 220.00 220.00						
01-07	0.00	0.00	01-23 0.00 0.00						
01-08	0.00	0.00	01-24 10.00 10.00						
01-09	0.00	0.00	01-25 0.00 0.00						
01-10	77.08	77.08	01-26 0.00 0.00						
01-11	0.00	0.00	01-27 0.00 0.00						
01-12	0.00	0.00	01-28 0.00 0.00						
01-13	0.00	0.00	01-29 0.00 0.00						
01-14	26.00	26.00	01-30 0.00 0.00						
01-15	0.00	0.00	01-31 0.00 0.00						
01-16	0.00	0.00							
<table border="1"> <tr> <td>Page</td> <td>Print</td> <td></td> <td></td> <td></td> <td></td> </tr> </table>				Page	Print				
Page	Print								

1. Query

Setting the date for query report, use [Left] or [Right] key to move the cursor, Press

report displays 12 hours' accumulation values on the screen.

2. Channel information

Display the channel's tag, units, range and other information.

3. Printer status

Display the printer is connected or not.

4. The total accumulated value

Display the total accumulative value of the channel.

5. 12-Hour accumulative value

Display accumulative value per 12 hours.

6. Print

If the printer is online, press [F2] key to print the accumulative report on the print screen.

(4) ACCUMULATIVE REPORT---DAILY REPORT SCREEN

Report-Daily		2010-06-20 17:18:25	
Date:	<input type="text" value="2010-01"/>	Chnl:	<input type="text" value="01"/>
Unit:	<input type="text" value="%"/>	Tag:	<input type="text" value="Chnl01"/>
Σ 49403.39		Scale:	<input type="text" value="0.0"/> ~ <input type="text" value="100.0"/>
		Print:	<input type="text" value="Print offline"/>
Day-Accumulate		Day-Accumulate	
01-01	0.00	01-17	0.00
01-02	256.00	01-18	256.00
01-03	120.05	01-19	120.05
01-04	78.05	01-20	54.06
01-05	65.38	01-21	65.38
01-06	0.00	01-22	220.00
01-07	0.00	01-23	0.00
01-08	0.00	01-24	1000.00
01-09	0.00	01-25	0.00
01-10	77.08	01-26	0.00
01-11	0.00	01-27	0.00
01-12	0.00	01-28	0.00
01-13	0.00	01-29	0.00
01-14	26.00	01-30	0.00
01-15	0.00	01-31	0.00
01-16	0.00		
<input type="text" value="Page"/> <input type="text" value="Print"/>			

1. Query

Setting the date for query report, use [Left] or [Right] key to move the cursor, Press [Up] or [Down] key to configure the time and channel .Press [En] to query data. The report displays daily accumulation values on the screen.

2. Channel information

Display the channel's tag, units, range and other information.

3. Printer status

Display the printer is connected or not.

4. The total accumulated value

Display the total accumulative value of the channel.

5. Daily accumulative value

Display accumulative value per day.

6. Print

If the printer is online, press [F2] key to print the accumulative report on the print screen.

7. Monthly report display

Press [F6] key to enter the monthly report of the channel.

(5) ACCUMULATIVE REPORT---MONTHLY REPORT SCREEN

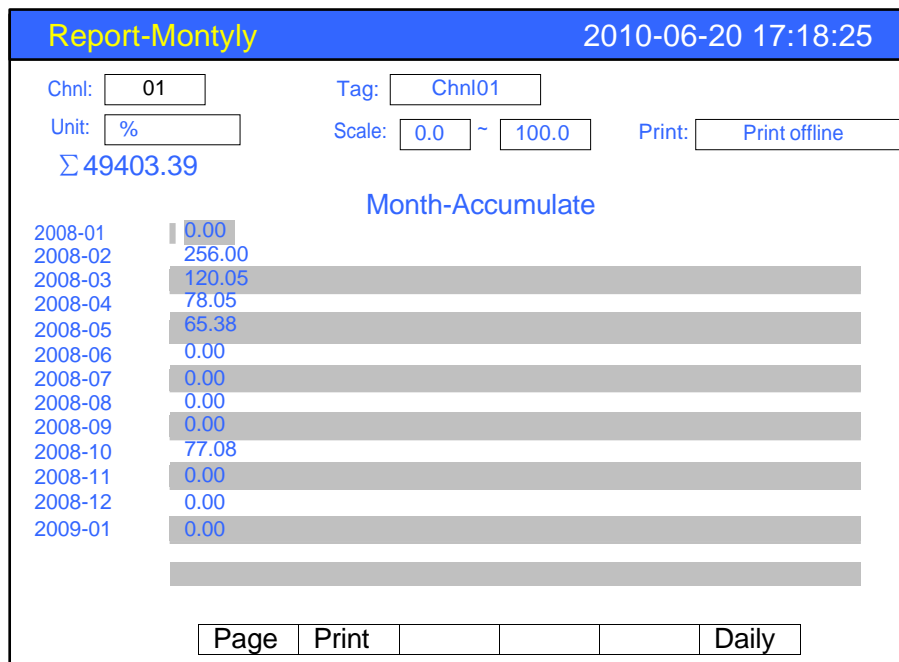

1. Query

Setting the date for query report, use [Left] or [Right] key to move the cursor, Press [Up] or [Down] key to configure the time and channel .Press [En] to query data. The report displays monthly accumulation values on the screen.

2. Channel information

Display the channel's tag, units, range and other information.

3. Printer status

Display the printer is connected or not.

4. The total accumulated value

Display the total accumulative value of the channel.

5. Monthly accumulative value

Monthly accumulative value per day.

6. Print

If the printer is online, press [F2] key to print the accumulative report on the print screen.

7. Daily report display

Press [F6] key to enter the daily report of the channel

CHAPTER5 SYSTEM CONFIGURATIONS

5.1 SETTING THE DATE AND TIME

Procedure

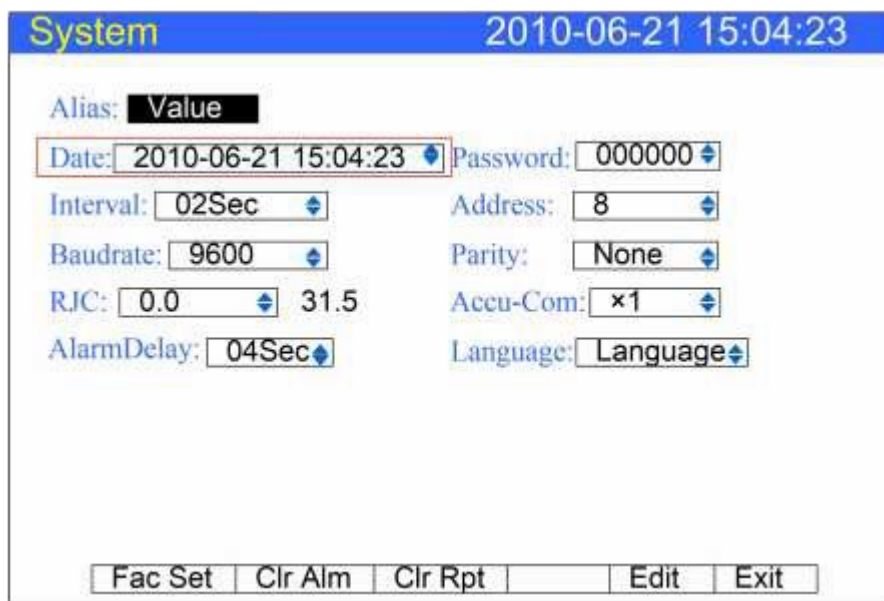

The screenshot shows the 'System' configuration screen with a blue header bar containing the title 'System' and the current date and time '2010-06-21 15:04:23'. Below the header, there are several configuration fields:

- Alias: Value
- Date: 2010-06-21 15:04:23 (highlighted with a red box)
- Password: 000000
- Interval: 02Sec
- Address: 8
- Baudrate: 9600
- Parity: None
- RJC: 0.0 31.5
- Accu-Com: x1
- AlarmDelay: 04Sec
- Language: Language

At the bottom of the screen, there is a row of buttons: Fac Set, Clr Alm, Clr Rpt, Edit, and Exit.

Set time

The current date and time of the instrument

Confirming operation

After the parameter setting, select [Exit] there is a Frame.

Select [Yes] to save setting content, and exit [System] screen.

Select [No] to cancel setting content, and exit [System] screen.

Select [Cancel] to continue setting parameters in [System] screen.

Caution

After setting system date / time, those historical data stored in instrument is invalid.

New and effective data begins after setting system date / time.

Before setting system date / time, please back up history data.

5.2 SETTING THE ALALIS

Set the device alias, device alias is displayed in the [Status column] of [digital screen].

Operation

Press the [Configuration key] to enter the configuration menu.

Use arrow keys and [En] to input the password, enter the [System] screen.

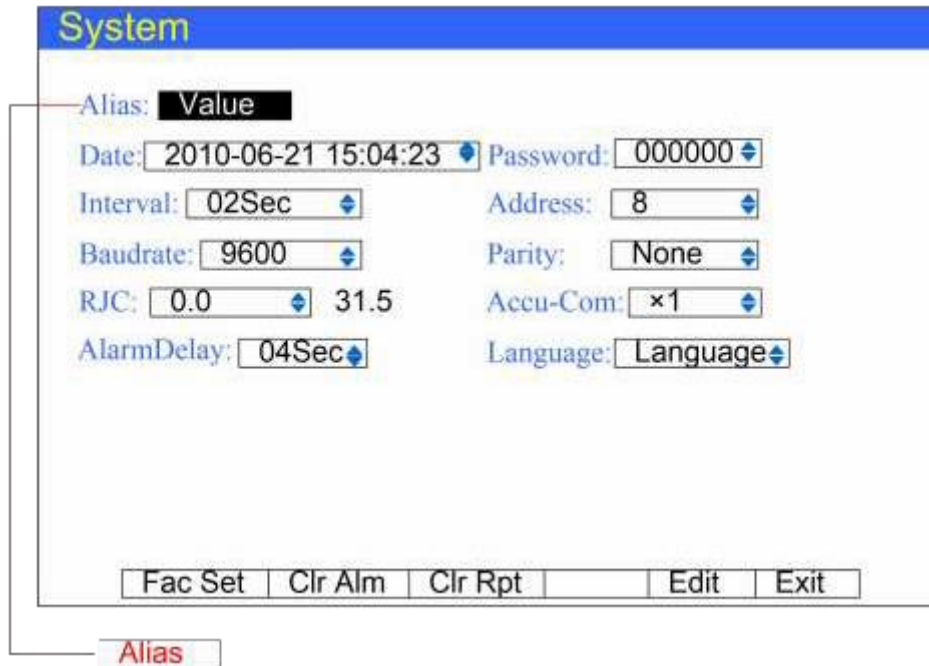

1. Setting device aliases

With regard to the input method on the editing parameters, please refer to the section 『common key operation 』

Confirming operation

After the parameter setting, select [Exit] there is a Frame.

Select [Yes] to save setting content, and exit [System] screen.

Select [No] to cancel setting content, and exit [System] screen.

Select [Cancel] to continue setting parameters in [System] screen.

5.3 SETTING THE SYSTEM PASSWORD

System password is used to modify configuration parameters and prevent the system parameters from being accidentally modified. System password is six digits.

Operation

Press [Page] and [En] at the same time, enter the configuration menu.

Use arrow keys and [En] to input the password, enter the [System] screen.

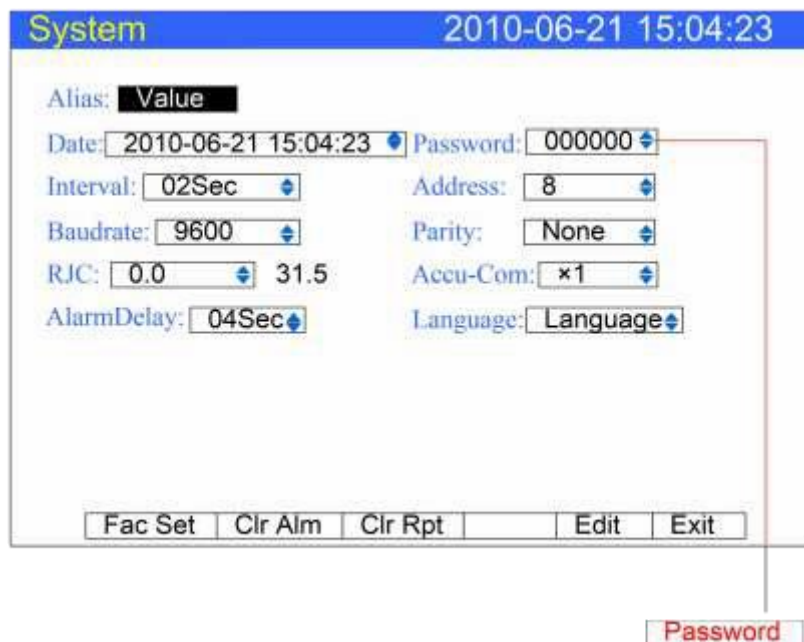

1. Set the system password

With regard to password input method, please refer to the section 『common key operation 』

Confirming operation

After the parameter setting, select [Exit] there is a Frame.

Select [Yes] to save setting content, and exit [System] screen.

Select [No] to cancel setting content, and exit [System] screen.

Select [Cancel] to continue setting parameters in [System] screen.

NOTE

The system password is the only password which can enter the system configuration to modify parameters. If it is lost, modification is unavailable.

The initial password is 000000, after the purchase please change password as soon as possible, and properly preserve it.

5.4 SETTING THE SCREEN BRIGHTNESS

Use the LCD screen brightness to adjust backlight brightness, can be set from 0 % to 100%.

Operation

Press the [Configuration key] to enter the configuration menu.

Use the arrow keys] and [En] button, enter the password, and then choose to enter [Display Configuration].

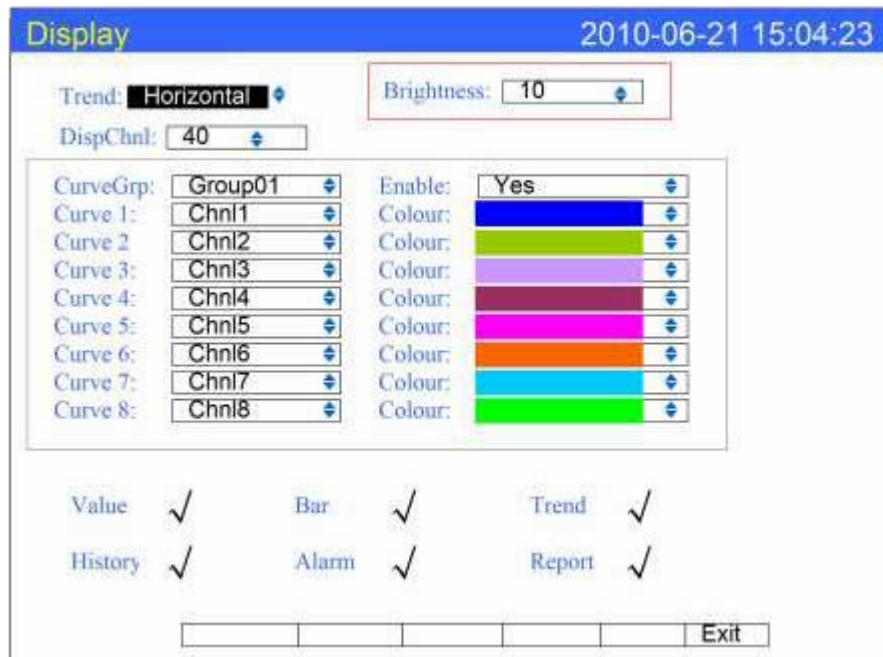

1.Set the screen brightness

With regard to the input method on the selection of parameters, please refer to 『Common key operation』 .

Confirming operation

After the parameter setting, select [Exit] there is a Frame.

Select [Yes] to save setting content, and exit [System] screen.

Select [No] to cancel setting content, and exit [System] screen.

Select [Cancel] to continue setting parameters in [System] screen.

Attention

LCD backlight life is inversely proportional to the backlight brightness, the lighter it is, the shorter life expectancy will it have. So do not set LCD screen particularly bright. Factory default setting is 10%.

5.5 SETTING TREND DIRECTION AND TREND COMBINATGION

User can choose two directions of trends, horizontal and vertical. When the horizontal, the trend is from right to left; when vertical, it's from up to down. Users can set 5 trend combinations, which can all be set to be enabled. Each trend combination is formed by 1-8 trends, which can choose 8 different colors.

Procedure

Press [Page] and [En] at the same time, enter the configuration menu.

Use arrow keys and [En] to input the password, enter the [Display] screen.

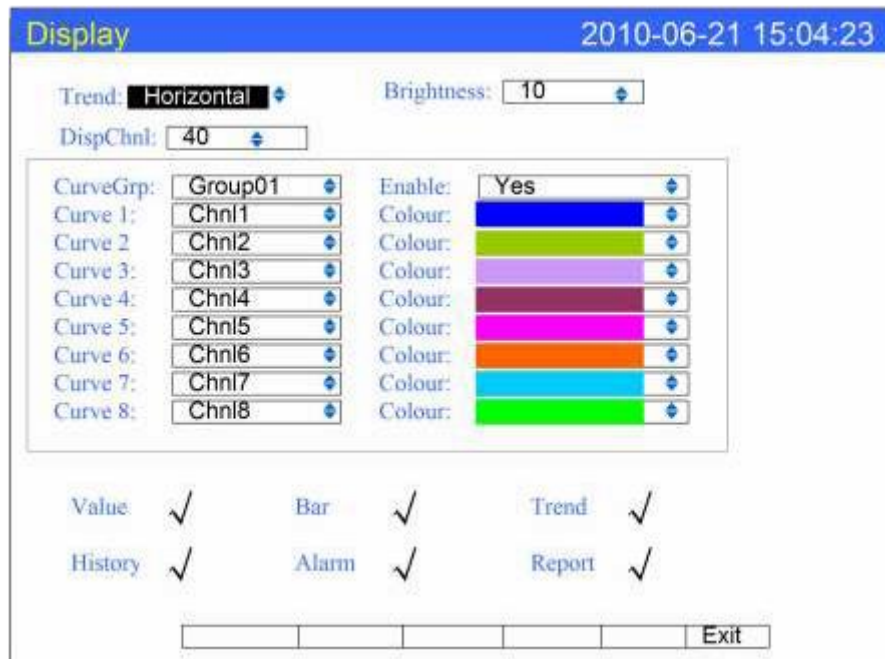

Set the trend direction

Press arrow keys to choose the trend direction (horizontal or vertical). It's also usable for Trend and History.

Select the current trend combination

Move the cursor to [curve combination], use the [Up] [down] keys to select the curve combination.

Set the current curve combination to be enabled or not

Move the cursor to the [Enable], use the [up] [down] keys to choose whether enable the current curve combination or not.

Set the current component channel of the trend combination and trend color

8 trends can be set to any input channel; the right side of this trend display color, a total number of 8 colors is available.

Confirming operation

After the parameter setting, select [Exit] there is a Frame.

Select [Yes] to save setting content, and exit [System] screen.

Select [No] to cancel setting content, and exit [System] screen.

Select [Cancel] to continue setting parameters in [System] screen.

5.6 VIEW SYSTEM INFORMATION

Display instrument information in the system information screen

Procedure

Press [Page] and [En] to enter configuration menu.

Use arrow keys and [En] to input the password, and then enter the [About] screen

Explanation

The hardware and software function

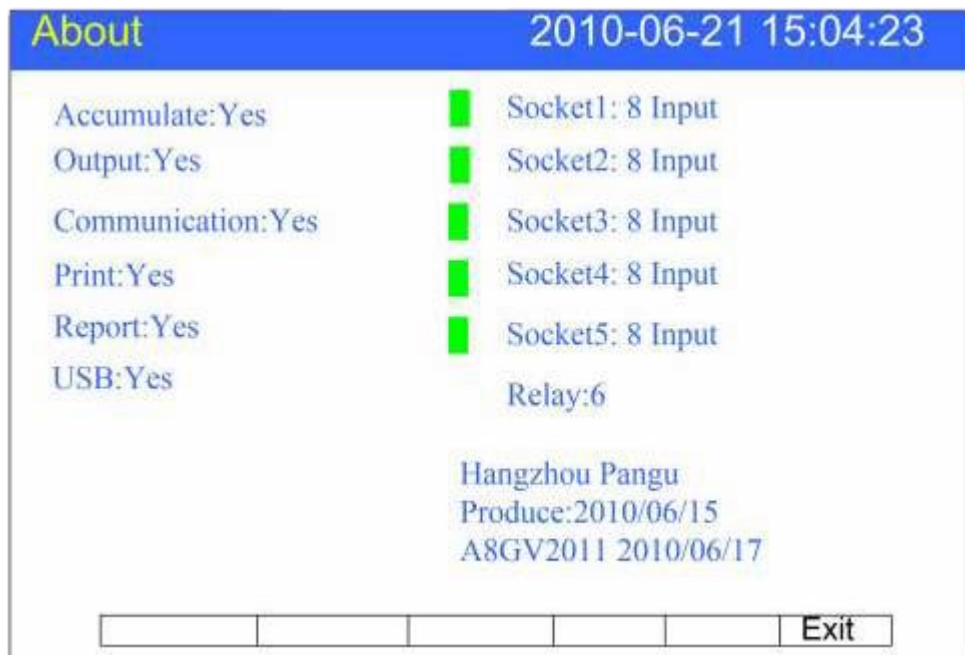

CHAPTER 6 INPUT SIGNAL SETTINGS

6.1 INPUT TYPE AND SCALING SETTING.

This section explains input signal type and range.

Procedure

Press [Page] and [En] at the same time, enter the configuration menu.

Use arrow keys and [En] to input the password, enter the [Analog Input] screen.

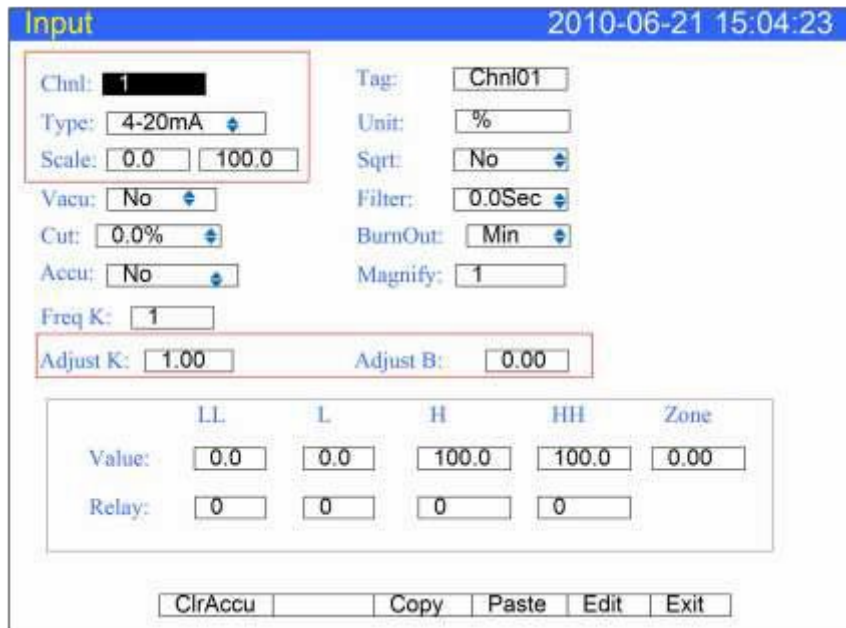

1. Input channel

Select the channel to set the parameter, which is limited by the input board channel's number.

2. Channel type

Set the current channel's input signal type.

3. Channel range

Set the current channel's input signal measuring range.

4. Adjusted value

Set the adjusted value of the current channel, display data measurement data * k + B.

Note

- The high and low value should not be the same.
- The low value is -9999 and high range is 19999.

Confirming operation

After the parameter setting, select [Exit] there is a Frame.

Select [Yes] to save setting content, and exit [System] screen.

Select [No] to cancel setting content, and exit [System] screen.

Select [Cancel] to continue setting parameters in [System] screen.

Specification**Measuring range**

Types, Range, Measuring range are as follows:

Type	Range	Measuring range
Current	4-20mA	4.00mA ~ 20.00mA
	0-10mA	0.00mA ~ 10.00mA
Voltage	1-5V	1.000V ~ 5.000V
	0-5V	0.000V ~ 5.000V
	0-10V	0.000V ~ 10.000V
	20mV	0.00mV ~ 20.00mV
	100mV	0.00mV ~ 100.00mV
Resistance	350Ω	0.0Ω ~ 350.0Ω
Frequency	FR	0Hz ~ 10000Hz
RTD	PT100	-200.0°C ~ 650.0°C
	Cu50	-50.0°C ~ 140.0°C
	Cu53	-50.0°C ~ 150.0°C
	BA1	-100°C ~ 600°C
	BA2	-100°C ~ 600°C
Thermocouple	S	-100°C ~ 1600°C
	R	-50°C ~ 1600°C
	B	500°C ~ 1800°C
	K	-50°C ~ 1300°C
	N	-200°C ~ 1300°C
	E	-100°C ~ 1000°C
	J	-100°C ~ 1000°C
	T	-100°C ~ 380°C
	WRE5-26	0°C ~ 2310°C
	WRE3-25	0°C ~ 2315°C
	F1	600°C ~ 2000°C
	F2	600°C ~ 2000°C
Simulation	Sin	Set the range freely.

For the reference junction compensation and burnout during the input of thermocouple, please refer to the section 『burnout and reference conduction compensation setting』

6.2 INPUT VACUUM TYPE AND SCALING SETTING

Here explains the input vacuum type and scaling setting

Procedure

Press [Page] and [En] at the same time, enter the configuration menu.

Use arrow keys and [En] to input the password, enter the [Analog Input] screen.

The screenshot shows the 'Input' configuration screen with the following settings:

- Chnl: 1
- Type: 4-20mA
- Scale: 0.0 to 100.0
- Vacu: No
- Cut: 0.0%
- Accu: No
- Freq K: 1
- Adjust K: 1.00
- Adjust B: 0.00
- Tag: Chnl01
- Unit: %
- Sqrt: No
- Filter: 0.0Sec
- BurnOut: Min
- Magnify: 1

	LL	L	H	HH	Zone
Value:	0.0	0.0	100.0	100.0	0.00
Relay:	0	0	0	0	

Buttons at the bottom: ClrAccu, Copy, Paste, Edit, Exit

1. Input channel

Select the channel to set the parameter, which is limited of the input board channel's number.

2. Set vacuum type

There are two vacuum types, normal arithmetic and subsection arithmetic. User can choose it based on vacuum transmitter signal.

3. Channel type

Set the current channel's input signal type.

4. Channel range

Set the current channel's input signal measuring range.

5. Adjusted value

when the method of signal measurement is the vacuum type, adjusted value has no effect.

Note

- The high and low value should not be the same.
- The low value is 1.0E-9 and high range is 1.0E+9. You can only change the index.

Confirming operation

After the parameter setting, select [Exit] there is a Frame.

Select [Yes] to save setting content, and exit [Input] screen.

Select [No] to cancel setting content, and exit [Input] screen.

Select [Cancel] to continue setting parameters in [Input] screen.

6.3 CHANNEL TAG AND UNIT SETTING

Here explains channel tag and unit.

Procedure

Press [Page] and [En] at the same time, enter the configuration menu.

Use arrow keys and [En] to input the password, enter the [Analog Input] screen.

The screenshot shows the 'Input' configuration screen with the following parameters:

- Chnl: 1
- Type: 4-20mA
- Scale: 0.0, 100.0
- Vacu: No
- Cut: 0.0%
- Accu: No
- Freq K: 1
- Adjust K: 1.00
- Tag: Chnl01
- Unit: %
- Sqrt: No
- Filter: 0.0Sec
- BurnOut: Min
- Magnify: 1
- Adjust B: 0.00

Below the main parameters is a table for relay settings:

	LL	L	H	HH	Zone
Value:	0.0	0.0	100.0	100.0	0.00
Relay:	0	0	0	0	

At the bottom of the screen are buttons: ClrAccu, Copy, Paste, Edit, and Exit.

1.Channel tag

Press [En] to input channel tag, it can input up to 10 English characters.

2.Channel unit

Press [En] to input channel tag, it can input up to 7 English characters.

Note

- Support input English
 - Channel unit and measuring signal calculation are independent.
-

Confirming operation

After the parameter setting, select [Exit] there is a Frame.

Select [Yes] to save setting content, and exit [Input] screen.

Select [No] to cancel setting content, and exit [Input] screen.

Select [Cancel] to continue setting parameters in [Input] screen.

6.4 INPUT FILTER SETTING

Procedure

Press [Page] and [En] at the same time, enter the configuration menu.

Use arrow keys and [En] to input the password, enter the [Input] screen.

The screenshot shows the 'Input' configuration screen with the following parameters:

- Chnl: 1
- Tag: Chnl01
- Type: 4-20mA
- Unit: %
- Scale: 0.0, 100.0
- Sqrt: No
- Vacu: No
- Filter: 0.0Sec (highlighted with a red box)
- Cut: 0.0%
- BurnOut: Min
- Accu: No
- Magnify: 1
- Freq K: 1
- Adjust K: 1.00
- Adjust B: 0.00

Below the main parameters is a table for hysteresis settings:

	LL	L	H	HH	Zone
Value:	0.0	0.0	100.0	100.0	0.00
Relay:	0	0	0	0	

At the bottom of the screen are buttons: ClrAccu, Copy, Paste, Edit, Exit.

1. Setting filter time constant

Set the filter time constant, the range is from 0.0S to 9.9S.

Confirming operation

After the parameter setting, select [Exit] there is a Frame.

Select [Yes] to save setting content, and exit [Input] screen.

Select [No] to cancel setting content, and exit [Input] screen.

Select [Cancel] to continue setting parameters in [Input] screen.

Explanations

Filter setting method:

Display value= (Last value ×Input filter + Current value)/ (Input filter +1)

6.5 BURNOUT SETTING

Here explains the setting method of burnout.

Procedure

Press [Page] and [En] at the same time, enter the configuration menu.

Use arrow keys and [En] to input the password, enter the [Input] screen.

The screenshot shows the 'Input' configuration screen for channel 1. The title bar displays 'Input' and the timestamp '2010-06-21 15:04:23'. The parameters are as follows:

- Chnl: 1
- Type: 4-20mA
- Scale: 0.0 to 100.0
- Vacu: No
- Cut: 0.0%
- Accu: No
- Freq K: 1
- Adjust K: 1.00
- Tag: Chnl01
- Unit: %
- Sqrt: No
- Filter: 0.0Sec
- BurnOut: Min (highlighted with a red box)
- Magnify: 1
- Adjust B: 0.00

Below these parameters is a table for limits and relay settings:

	LL	L	H	HH	Zone
Value:	0.0	0.0	100.0	100.0	0.00
Relay:	0	0	0	0	

At the bottom of the screen are buttons for 'ClrAccu', 'Copy', 'Paste', 'Edit', and 'Exit'.

1. Setting method of burnout

Setting	Result
Minimum	Low limit
Maximum	High limit
Hold the previous value	Keep it fixed at the finally right value before burnout
Error flag	#####

Confirming operation

After the parameter setting, select [Exit] there is a Frame.

Select [Yes] to save setting content, and exit [Input] screen.

Select [No] to cancel setting content, and exit [Input] screen.

Select [Cancel] to continue setting parameters in [Input] screen.

6.6 REFERENCE JUNCTION COMPENSATION

Here explains how to set reference junction compensation.

Procedure

Press [Page] and [En] at the same time, enter the configuration menu.

Use arrow keys and [En] to input the password, enter the [System] screen.

The screenshot shows the 'System' configuration screen with a blue header bar containing the title 'System' and the timestamp '2010-06-21 15:04:23'. The screen displays several configuration parameters, each with a text label and a value field. The 'RJC' parameter is highlighted with a red rectangular box. At the bottom of the screen, there is a row of buttons: 'Fac Set', 'Clr Alm', 'Clr Rpt', 'Edit', and 'Exit'.

Alias:	Value
Date:	2010-06-21 15:04:23
Password:	000000
Interval:	02Sec
Address:	8
Baudrate:	9600
Parity:	None
RJC:	0.0 31.5
Accu-Com:	x1
AlarmDelay:	04Sec
Language:	Language

1. CJ compensational value

When there are some differences between the scene temperature and the cold temperature instrument measured, user can use the adjust function. Pressing the [Up and down] keys to set the value.

Compensation value= CJ measurement value + CJ adjusted value

Confirming operation

After the parameter setting, select [Exit] there is a Frame.

Select [Yes] to save setting content, and exit [System] screen.

Select [No] to cancel setting content, and exit [System] screen.

Select [Cancel] to continue setting parameters in [System] screen.

6.7 ACCUMULATION SETTING

Here explains how to set channel accumulation function.

Procedure

Press [Page] and [En] at the same time, enter the configuration menu.

Use arrow keys and [En] to input the password, enter the [Analog input] screen.

LL	L	H	HH	Zone
Value: 0.0	0.0	100.0	100.0	0.00
Relay: 0	0	0	0	

Set the accumulated function

Move the cursor to [Accumulate], use [Up] and [Down] to set the accumulate function.

Set the accumulated magnification

Move the cursor to the [Accu magnification], use the [up] [down] keys to modify the accumulative magnification or edit in the input box.

Confirming operation

After the parameter setting, select [Exit] there is a Frame.

Select [Yes] to save setting content, and exit [Input] screen.

Select [No] to cancel setting content, and exit [Input] screen.

Select [Cancel] to continue setting parameters in [Input] screen.

Explanation

- Accumulation function carries out time integral for current channel measurement value and arithmetic value.
- The range of accumulation value is 0 ~ 9,999,999,999.9, 2 radix point.
- It will clear voluntarily when accumulate value exceeding 9,999,999,999.9.
- When enabled the accumulation function; the accumulation value can be displayed in the overview screen automatically.

6.8 COPYING CHANNEL PARAMETERS

Here explains how to copy channel parameters.

Use this function when channel A and channel B need to set the same parameter.

Procedure

Press [Page] and [En] at the same time, enter the configuration menu.

Use arrow keys and [En] to input the password, enter the [Input] screen.

	LL	L	H	HH	Zone
Value:	0.0	0.0	100.0	100.0	0.00
Relay:	0	0	0	0	

Copy the channel parameter

Move the cursor to [Channel].

Use the [Up] and [Down] to adjust and copy source channel, and press the [F3] to copy the source channel.

Use the [Up] and [Down] to adjust and copy purpose channel, and press the [F3] to paste to purpose channel.

Confirming operation

After the parameter setting, select [Exit] there is a Frame.

Select [Yes] to save setting content, and exit [Input] screen.

Select [No] to cancel setting content, and exit [Input] screen.

Select [Cancel] to continue setting parameters in [Input] screen.

Explanations

Copy operations: copy the following parameters:

Type / Units / Range / accumulation / Sqrt / vacuum / filter / cut / low low alarm / low alarm / high alarm / high high alarm / zone / 4 contacts setting / adjusted value.

6.9 SQUARE ROOT COMPUTATION AND SMALL SIGNAL CUTTING

Here explains the square root computation and small signal cutting function in the flow measurement.

Procedure

Press [Page] and [En] at the same time, enter the configuration menu.

Use arrow keys and [En] to input the password, enter the [Input] screen.

The screenshot shows the 'Input' configuration screen with the following parameters:

- Chnl: 1
- Tag: Chnl01
- Type: 4-20mA
- Unit: %
- Scale: 0.0 to 100.0
- Sqrt: No
- Filter: 0.0Sec
- BurnOut: Min
- Magnify: 1
- Cut: 0.0%
- Accu: No
- Freq K: 1
- Adjust K: 1.00
- Adjust B: 0.00

	LL	L	H	HH	Zone
Value:	0.0	0.0	100.0	100.0	0.00
Relay:	0	0	0	0	

Buttons at the bottom: ClrAccu, Copy, Paste, Edit, Exit

1. Set the square root computation

Move the cursor to [Sqrt], enabled the square root computation with [Up] and [Down] keys.

2. Set the small signal cutting

Move the cursor to [Cut], modify the small signal cutting percent with [Up] and [Down] keys.

If the signal is smaller than the signal cutting percent, it will be forced into lower limit of measurement range.

Confirming operation

After the parameter setting, select [Exit] there is a Frame.

Select [Yes] to save setting content, and exit [Input] screen.

Select [No] to cancel setting content, and exit [Input] screen.

Select [Cancel] to continue setting parameters in [Input] screen.

Explanation

- Need to use to square root function in measurement differential pressure flow meter in pore plate, and a few flow meters which is not bringing the square root function can use this function.
- small signal cutting is used to solve the problem that the real flow shows zero while the measurement flow is not zero.

CHAPTER 7 SETTING ALARMS

7.1 CHANNEL ALARM SETTING.

Each channel can set four alarm values, high high alarm, high alarm, low alarm and low low alarm.

CAUTION

- Set the measurement range before setting the alarm.
- All of the alarm settings of a channel are canceled in the following cases:
 - 1)When the signal type is changed(Voltage, Resistance)
 - 2)When the input range is changed
 - 3) When there is the square root operation setting

Procedure

Press [Page] and [En] at the same time, enter the configuration menu.

Use arrow keys and [En] to input the password, enter the [Alarm] screen.

The screenshot shows the 'Input' configuration screen for channel 1. The title bar indicates the date and time as 2010-06-21 15:04:23. The screen is divided into several sections for parameter configuration:

- Channel Information:** Chnl: 1, Tag: Chnl01
- Signal Type and Range:** Type: 4-20mA, Unit: %, Scale: 0.0 to 100.0, Sqrt: No
- Filtering and Accuracy:** Vacu: No, Filter: 0.0Sec, BurnOut: Min, Magnify: 1
- Frequency and Adjustment:** Freq K: 1, Adjust K: 1.00, Adjust B: 0.00
- Alarm Thresholds:** A table with columns for LL, L, H, HH, and Zone. The 'Value' row shows 0.0, 0.0, 100.0, 100.0, and 0.00. The 'Relay' row shows 0, 0, 0, 0, and 0.
- Buttons:** ClrAccu, Copy, Paste, Edit, Exit

1. Select the alarm channel

The setting method is the same as the signal type and signal range

2. Set the alarm threshold value

The threshold value must in the channel range.

3. Set the alarm threshold value zone

Prevent the relay frequent action when the signal is surged by the alarm threshold value.

4. Set relay contact

Output the relay which has been setted with serial number when an alarm occurs.

Confirming operation

After the parameter setting, select [Exit] there is a Frame.

Select [Yes] to save setting content, and exit [Alarm] screen.

Select [No] to cancel setting content, and exit [Alarm] screen.

Select [Cancel] to continue setting parameters in [Alarm] screen.

Explanation

Alarm condition and Undo Alarm condition

Threshold		
Type	Alarm condition	Undo Alarm condition
High-high threshold	Channel value > high-high threshold	Channel value < high-high threshold-zone.
High threshold	Channel value > high threshold	Channel value < high threshold-zone.
Low threshold	Channel value < low threshold	Channel value > low threshold + zone.
Low low threshold	Channel value < low-low threshold	Channel value > low-low threshold + zone.

Relay contact setting

- Alarm doesn't output to relay when the relay number setting is zero.
- When sharing an alarm output relay among multiple alarms, each alarm will make the relay activated.

Relay delay to contact

For preventing the relay's mistake, relay delay time can set 0-10 seconds to delay trigger under the system configuration.

After the alarm, if the signal is under alarm state for continuous seconds, the relay will act.

Normally closed relay (Option)

The Initialization is normally opened relay, if you need normally closed relay, please contact us.

CHAPTER 8 SETTING ANALOG OUTPUTS

8.1 ANALOG OUTPUTS SETTING

The instrument provides 4-20mA analog output. This section describes how to set transmitter output parameters.

Procedure

Press [Page] and [En] at the same time, enter the configuration menu.

Use arrow keys and [En] to input the password, enter the [Output] screen.



1. Set the output source channel
Set the source of this channel output value.
2. Output the adjust value
Output value = Current value × K + B。

Confirming operation

After the parameter setting, select [Exit] there is a Frame.
 Select [Yes] to save setting content, and exit [Output] screen.
 Select [No] to cancel setting content, and exit [Output] screen.
 Select [Cancel] to continue setting parameters in [Output] screen.

Explanation

- The analog output only supports 4-20mA
- According to the channel measurement range converts the source channel value to percentage, then transforms to 4-20mA analog output.
When there is no output source channel , the analog output will fix to 4mA。

CHAPTER9 DATA STORAGE AND BACKUP

9.1 SETTING THE SAVING INTERVAL OF DATA STORAGE

Here explains how to set recording interval of data storage.

Procedure

Press [Page] and [En] at the same time, enter the configuration menu.

Use arrow keys and [En] to input the password, enter the [System] screen.

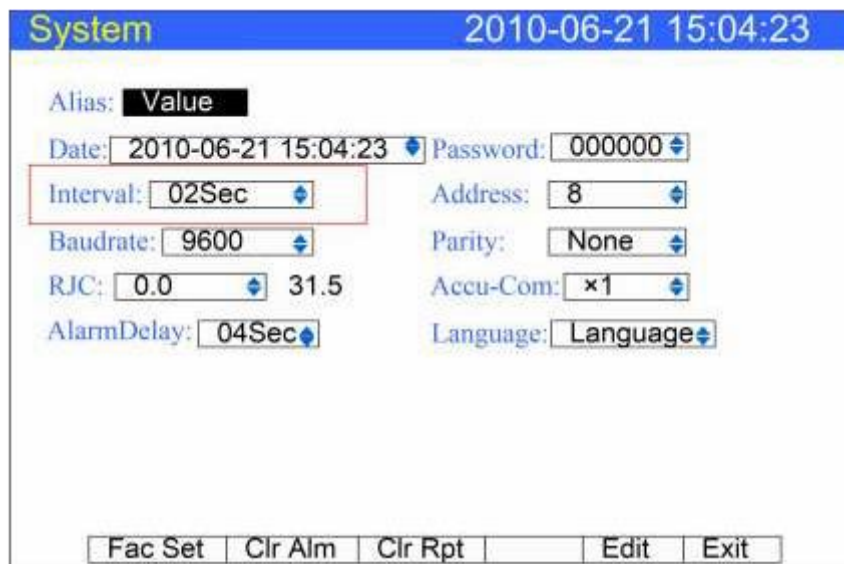

1. Set the saving interval

User can choose 1s/2s/5s/10s/15s/30s/1min/2min/4min.

Confirming operation

After the parameter setting, select [Exit] there is a Frame.

Select [Yes] to save setting content, and exit [System] screen.

Select [No] to cancel setting content, and exit [System] screen.

Select [Cancel] to continue setting parameters in [System] screen.

Explanation

The sample period is 1 second, so the smallest records interval is 1 second.

Increasing the interval can prolong the time length of storage data.

Note

The interior saving historical data will be invalid if you modify the

saving interval, therefore, please back up the historical data before you modify it to prevent the loss.

The relation of the saving interval and time length

Saving interval	Time length
1 second	72 hour/channel
2 second	6 day/ channel
5 second	15 day/ channel
10 second	30 day/ channel
15 second	45 day/ channel
30 second	90 day/ channel
1 minute	180 day/ channel
2 minute	360 day/ channel
4 minute	720 day/ channel

9.2 SAVING HISTORIACL DATA TO EXTERNAL STORAGE MEDIUM

This section explains how to use the U disk to back up historical data.

Procedure

In operation screen, press [backup] to enter data backup screen.

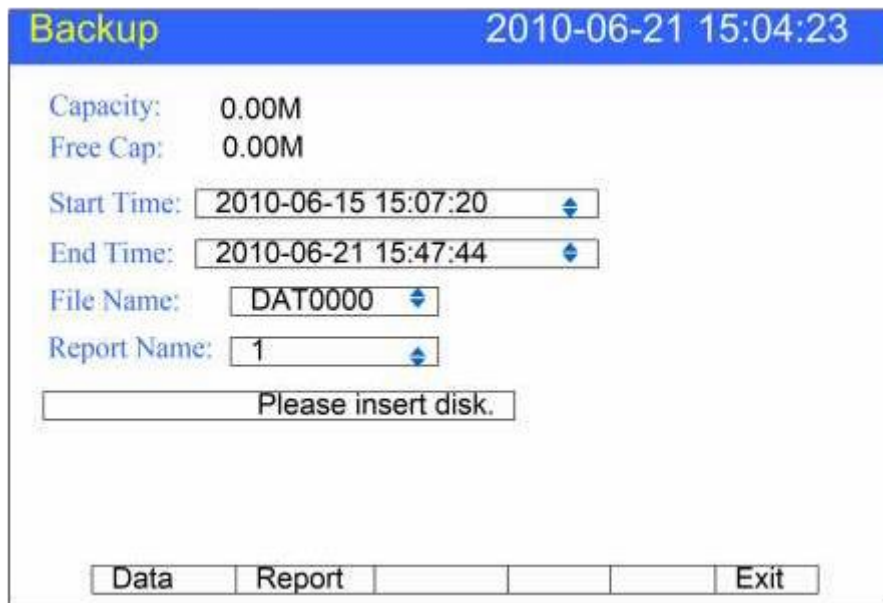

1. Modify the time to back up data
Select the time to to back up data.
2. Modify the file name
Modify the filename which is backed up in the U disk
3. Back up data
Move the cursor to [Backup] button; press [En] to execute the data backup operation.

Explanation

The meanings of the status bar information

Item	Contents
Please insert the flash disk!	Instrument has't detected the U disk on the USB interface.
...Find the hardware...	Measure the U Disk information and available space
Initialization succeeds!	Finish U Disk checking and have good preparation for data backup.
Back up the file (Blue schedule)	Backup now, please wait for it
Backup is finished!	Backup is finished; you can pullout the U Disk.
File of the same name exists!	The same name document has existed, change the name of this file and back up again.
Backup fails!	Format the disk, and backup again.

CHAPTER10 SETTING COMMUNICATION PARAMETERS

10.1 COMMUNICATION USING RS232C (OPTION)

Here explains how to use RS232C for communication.

Procedure

Press [Page] and [En] at the same time, enter the configuration menu.
 Use arrow keys and [En] to input the password, enter the [Communication] screen.

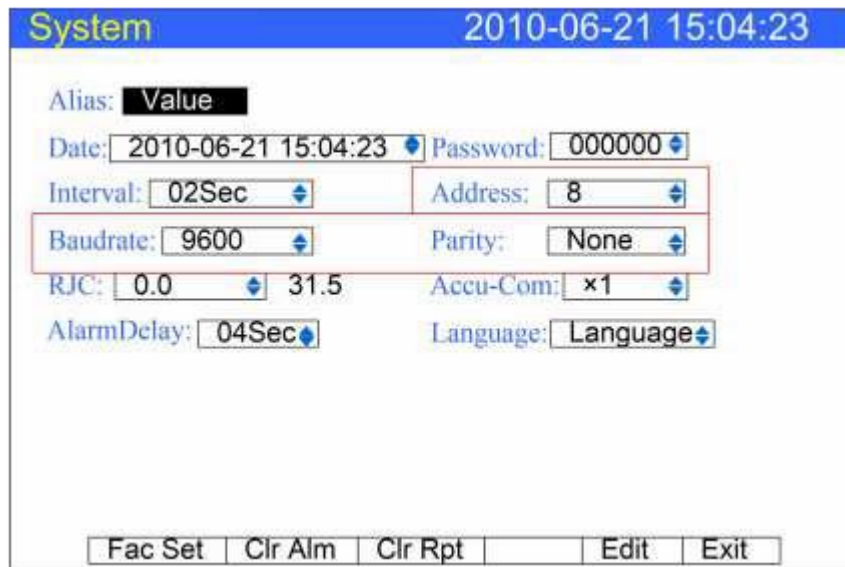

Item	Content
Address	1 - 254
Communication baud rate	1200/2400/4800/9600/19200/38400/57600
Communication parity mode	None/Odd/Even

Confirming operation

After the parameter setting, select [Exit] there is a Frame.
 Select [Yes] to save setting content, and exit [Communication] screen.
 Select [No] to cancel setting content, and exit [Communication] screen.
 Select [Cancel] to continue setting parameters in [Communication] screen.

Explanation

1. Connects communication wiring.
2. Setting the instrument's communication address, baud rate, parity.
3. The setting of the PC's communication address, baud rate, and parity are the same with the instruments.
4. Use it.

The port of RS232C is DB9. Where,
2 -> D, 3 -> TXD, 5 -> GND

Note

The instrument's RS485 port uses 7 and 8 two pin in DB9 port, if user has ordered two RS232C and RS485 function at the same time; don't use 9 core connecting lines to link up with instrument and PC machine, two of RS485 pin communication that can disturb RS232C, makes communication fail.

Use 3 core communication lines and PC machine to link up

10.2 COMMUNICATION USING RS485 (OPTION)

Here explains how to use RS485 for data communication.

Procedure

Press [Page] and [En] at the same time, enter the configuration menu.

Use arrow keys and [En] to input the password, enter the [Communication] screen.

Item	Content
Address	1 - 254
Communication baud rate	1200/2400/4800/9600/19200/38400/57600
Communication parity mode	None/Odd/Even

Confirming operation

After the parameter setting, select [Exit] there is a Frame.

Select [Yes] to save setting content, and exit [Communication] screen.

Select [No] to cancel setting content, and exit [Communication] screen.

Select [Cancel] to continue setting parameters in [Communication] screen.

Explanation

1. Connects communication wiring. If connecting PC, use 232-485 covering modes.
2. Sets the instrument's communication address, baud rate, parity mode.
3. The setting of the PC's communication address, baud rate, and parity mode are the same with the instruments.
4. Use it.

The port of RS485 is DB9. Where,
7 → 485+, 8 → 485-

Note

- Allow multiple instruments to connect to RS485 network. Use the type of the bus-based connections.
 - When the link of the RS485 is further or the interference in the connecting with the bus is larger. Add 120Ω resistance at both ends in the network. Connection is between the 485+ and 485-.
-

10.3 CONNECT WITH MICRO PRINTER (OPTION)

If there is need for printing, the instrument can connect with the micro printer.

Operation:

In the operation screen, press the [Print] to enter print screen.

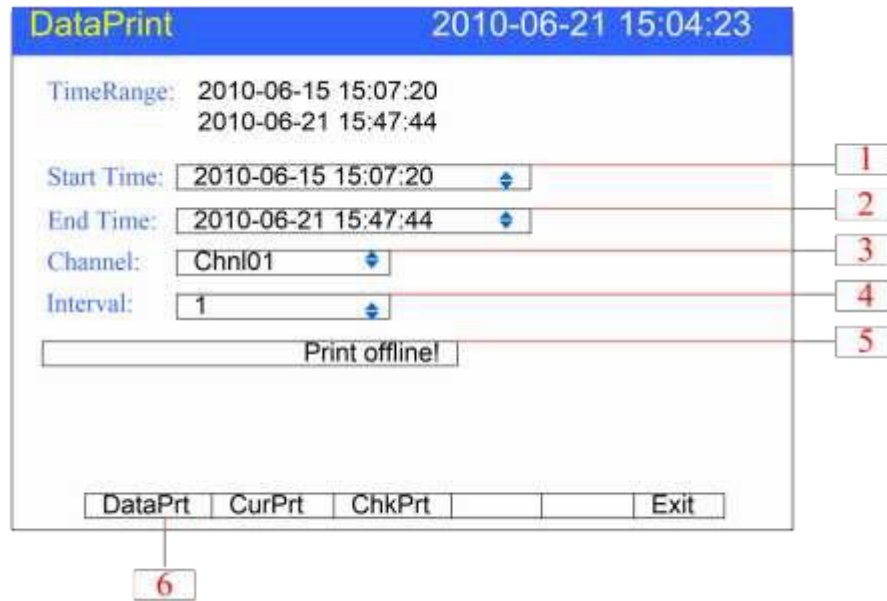

Procedure

1. Set the printer's start time
2. Set the printer's end time
3. Select the print channel
4. Set the interval
5. Check printer status. The checking result will display at the printer status column. It can print only the printer is on line.
6. Print the data or trend

Explanation

Use the RS232C port (DB9) to connect the instrument and the printer

Port of the instrument	Printer port
D	RTS
TXD	D
GND	GND

The instrument doesn't need to set communication parameter

Set the printer's communication parameter

Baud rate	9600
Start bit	1
Data bit	8
Parity	None

10.4 TIMER PRINT FUNCTION SETTING

This section describes how to set the start time and end time of time print.

Procedure

Press [Page] and [En] at the same time, enter the configuration menu.

Use arrow keys and [En] to input the password, enter the [Timer] screen.

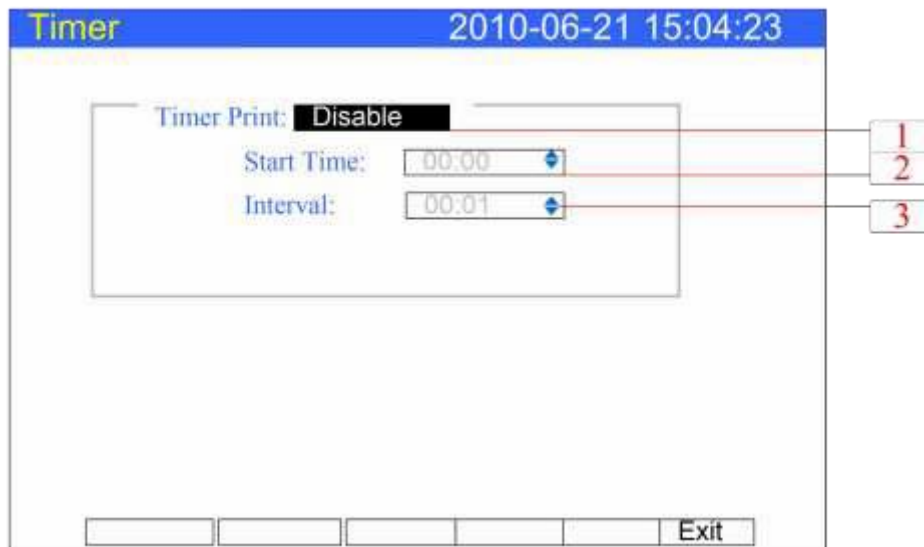

1. Set the timer print function

Move the cursor to [Timer Prt], choose it with [Up] and [Down] [Yes]

: The timer print function is opened.

[No]: The timer print function is closed.

2. The starting time

3. Interval: Between two printing intervals.

Confirming operation

After the parameter setting, select [Exit] there is a Frame.

Select [Yes] to save setting content, and exit [Timer] screen.

Select [No] to cancel setting content, and exit [Timer] screen.

Select [Cancel] to continue setting parameters in [Timer] screen.

Note

- When use the timer print function, the printer must connect with the communication port all the time.
 - About the printer setting, see section 『connect with miniprint』.
 - There is an indication when print
-

CHAPTER 11 INITIALIZING DATA

11.1 RESTORE FACTORY SETTING

This section describes the methods to restore factory setting and affecting parameters.

Procedure

Press [Page] and [En] at the same time, enter the configuration menu.

Use arrow keys and [En] to input the password, enter the [system] screen.

The screenshot shows a 'System' configuration screen with a blue header bar containing the title 'System' and the timestamp '2010-06-21 15:04:23'. Below the header, several configuration parameters are listed, each with a text input field and a dropdown arrow:

- Alias: Value
- Date: 2010-06-21 15:04:23
- Password: 000000
- Interval: 02Sec
- Address: 8
- Baudrate: 9600
- Parity: None
- RJC: 0.0 31.5
- Accu-Com: x1
- AlarmDelay: 04Sec
- Language: Language

 At the bottom of the screen, there is a row of buttons: 'Fac Set', 'Clr Alm', 'Clr Rpt', 'Edit', and 'Exit'. The 'Fac Set' button is highlighted with a red rectangular box.

Restore factory setting

Press [F 1]

Confirming operation

Select [Yes] and press [En] to restore factory setting.

Select [No] and press [En] to cancel factory setting.

After Restore Factory setting, select [Exit] there is a Frame.

Select [Yes] to save setting content, and exit [System] screen.

Select [No] to cancel setting content, and exit [System] screen.

Select [Cancel] to continue setting parameters in [System] screen.

Note

After factory setting, the historical data stored in instrument will be cleared.

Before the factory setting, please back up the historical data.

Explanation

The influencing parameter tabulation

Type	Name	Value of parameters
System parameters	Alias	Overview
	Password	000000
	Direction	Horizontal
	Screen brightness	10
	Trend combination 1	enabled trend 1 – channel1 – blue trend 2 – channel2 – dark green trend 3 – channel3 – deep purple trend 4 – channel 4 – brown trend 5 – channel 5 – purple trend 6 – channel6 – orange trend 7 – channel7 – blue trend 8 – channel 8 – green
	Trend combination 2 – 4	Not enabled
Data save parameter	Interval	02 seconds
Communication parameter	Address	8
	Baud rate	9600
	Parity	None
	Relay delay	4seconds
	Timing printer	Prohibited
Analog input parameter (all channels)	Tag	Channel[No.]
	Type	4-20mA
	Unit	%
	Lower limit	4.00
	Upper limit	20.00
	Accumulation	no
	Vacuum	No
	Filter	0.0second
	Burnout setting	Minimum
	Cold junction adjustment	0.0
	Accumulative magnification	1
	Adjust value K	1.00

	Adjust value B	0.00
Alarm parameter (all channels)	Alarm low low threshold	4.00
	Alarm low threshold	4.00
	Alarm high threshold	20.00
	Alarm high high threshold	20.00
	Alarm contact(all alarm)	0
Analog output parameter (all loops)	Analog output	none
	Adjust value K	1.00
	Adjust value B	0.00
Configuration parameters of report	Type of report	Daily report
	Time of settlement	0:00

11.2 PURGE ALARM SUMMARY

Here explains the methods to purge alarm summary.

Procedure

Press [Page] and [En] at the same time, enter the configuration menu.

Use arrow keys and [En] to input the password, enter the [system] screen.

System		2010-06-21 15:04:23	
Alias:	<input type="text" value="Value"/>	Date:	<input type="text" value="2010-06-21 15:04:23"/>
Interval:	<input type="text" value="02Sec"/>	Password:	<input type="text" value="000000"/>
Baudrate:	<input type="text" value="9600"/>	Address:	<input type="text" value="8"/>
RJC:	<input type="text" value="0.0"/> 31.5	Parity:	<input type="text" value="None"/>
AlarmDelay:	<input type="text" value="04Sec"/>	Accu-Com:	<input type="text" value="x1"/>
		Language:	<input type="text" value="Language"/>

<input type="text"/>	Fac Set	Clr Alm	<input type="text" value="Clr Rpt"/>	<input type="text"/>	Edit	Exit
----------------------	---------	---------	--------------------------------------	----------------------	------	------

Purge Alarm Summary

Press [F2]

Confirming operation

Select [Yes] and press [En] to purge alarm summary.

Select [NO] and press [En] to cancel purge alarm summary.

After Purge Alarm Summary, select [Exit] there is a Frame.

Select [Yes] to save setting content, and exits [System] screen.

Select [No] to cancel setting content, and exits [System] screen.

Select [Cancel] to continue setting parameters in [System] screen.

Explanation

Clearing alarm list will eliminate alarm records in memory, and can not be recovered.

Clearing alarm list will not affect other parameters and functions of this instrument.

11.3 PURGE ACCUMULATION REPORT

Here explains the methods to purge accumulation.

Procedure

Press [Page] and [En] at the same time, enter the configuration menu.

Use arrow keys and [En] to input the password, enter the [System] screen.

Clear Accumulation

Press [F 3]

Confirming operation

Select [Yes] and press [En] to purge accumulation data.

Select [NO] and press [En] to cancel purge accumulation data.

After Purge Alarm Summary, select [Exit] there is a Frame.

Select [Yes] to save setting content, and exits [Accumulation] screen.

Select [No] to cancel setting content, and exits [Accumulation] screen.

Select [Cancel] to continue setting parameters in [Accumulation] screen.

Explanation

Clearing accumulation will eliminate accumulation records in memory, and can not be recovered.

Clear accumulative reports will clear the total accumulation.

CHAPTER 12 SPECIFICATIONS

12.1 SIGNAL INPUT AND ALARM

Measurement input

Item	Specifications
The number of input channels	Simultaneously measuring up to 40 input channels
Measurement period	2seconds
Signal type	DC current (I), DC voltage (V), thermocouple (TC), thermal resistance (RTC), frequency (FR)

Input measurement range and the measurable range

Type	Range	Measurable range
Current	4-20mA	4.00mA ~ 20.00mA
	0-10mA	0.00mA ~ 10.00mA
Voltage	1-5V	1.000V ~ 5.000V
	0-5V	0.000V ~ 5.000V
	0-10V	0.000V ~ 10.000V
	20mV	0.00mV ~ 20.00mV
	100mV	0.00mV ~ 100.00mV
Resistance	350Ω	0.0Ω ~ 350.0Ω
Frequency	FR	0Hz ~ 10000Hz
RTD	PT100	-200.0°C ~ 650.0°C
	Cu50	-50.0°C ~ 140.0°C
	Cu53	-50.0°C ~ 150.0°C
	BA1	-100°C ~ 600°C
	BA2	-100°C ~ 600°C
Thermocouple	S	-100°C ~ 1600°C
	R	-50°C ~ 1600°C
	B	500°C ~ 1800°C
	K	-50°C ~ 1300°C
	N	-200°C ~ 1300°C
	E	-100°C ~ 1000°C
	J	-100°C ~ 1000°C
	T	-100°C ~ 380°C
	WRE5-26	0°C ~ 2310°C
	WRE3-25	0°C ~ 2315°C

	F1	600°C ~ 2000°C
	F2	600°C ~ 2000°C

Measuring current: I = 0.5mA (resistance, RTC)

Thermocouple burnout	Choose the maximum, minimum, error flag or keeping the former displayed value Standard: $\leq 2k\Omega$, burnout: $\geq 100k\Omega$ Check current: About 2.5uA
----------------------	---

Item	Specifications
Thermocouple cold junction compensation	Using internal cold junction compensation, the compensation accuracy : ± 0.5 °C
Digital filter	0 ~ 9.9 seconds inertia filter
Vacuum operation	
General algorithm	LOG curve is used in the whole range
Sub-algorithm	Linear operation is used in every section

Alarm

Item	Specifications
The number of alarms	Each channel has 4 alarm
Alarm type	High high alarm , high alarm, low alarm, low low alarm,
Alarm delay time	0-10s(applies to each channel)
Alarm output	Alarm outputs to the internal relay Internal relay number: 24 Internal relay operations: OR operation
Delay	0.0% ~ 100% of the range
Display	When alarm occurs, the corresponding screen displays the alarm status; the status display section displays the alarm icon.
Alarm information	Display alarm log in the alarm list

12.2 DISPLAY SPECIFICATIONS

Display

Item	Specifications
Display *	10.4-inch TFT color LCD display (640×480 points)
Brightness	0 ~ 100% adjustment

* LCD display section may contain the pixels which often shine or eliminate, due to the different LCD features, LCD brightness may not be the same, this is not a fault.

Display Information

Item	Specifications
Display group	Allocate channels to the groups on the real-time trend and history trend and then display them
Group number	5
Channels which can be allocated to groups	< 8
Display color	256 colors
Real-time curve display	Renewal rate 1 record interval Waveform width 1 pixel Display method Display perpendicular axes with timeline (T) and the measurement axis (Y) Layout: horizontal, vertical Curve cycle: recording interval × 30 div
Ruler	Ruler to display each channel (0% ~ 100%)
Digital Display	Display measured values with digital
Update Rate	2seconds
Bar graph display	Display measured value on the bar graph
Update Rate	2seconds
Ruler	0% ~ 100%
Historical curves show	Display stored data in the memory
Timeline operation	Can enlarge one times / 2 times / 4 times / 8 times / 16 times / 32 times
Alarm list display	Display up to 187 alarm records

Other Display Information

Item	Specifications
Channel tag	Ten letters (numbers)
Channel units	Seven letters (numbers)
Status display section	Show the status of this instrument in the upper part of the display screen
Display content	Screen name, board status, alarm status , USB condition, circular display status, searching status, year, month, day, hour, minute, seconds
Automatic switch of display group	At the specified time interval to switch display groups Time interval: 5 seconds
Language	English
System information display	Show the number of input and output card channels, relay output channels, instrument additional features, firmware version, and released date

12.3 DATA STORAGE SPECIFICATIONS

Setting

Item	Specifications
External storage media	Back up the recorded data in the device
Media	U Disk
Capacity	Up to 1GB
File format	FAT32
File Name	DAT+ "number"
Report Name	REP+ "number"

Data type

Item	Specifications
Data Size	
Sampled data	2 bytes/ data values
Cumulative amount	4 bytes/ data values
Data Format	Binary Data
The sampling period	equal to recording interval
Recording method	Always recording

12.4 OTHER STANDARD FUNCTIONS

Time-related functions

Item	Specifications
Clock	Can operate in 2000 ~ 2099
Clock Accuracy	$\pm 10\text{ppm}$ (0 ~ 50 °C), does not include the delay caused by the error when the power is on (less than 1 second)
Life of clock battery	About 10 years (under room temperature)

The type of characters which can be input

Item	Specifications
Characters	English (uppercase, lowercase), numbers, and symbols (within limitations)

12.5 SELECT FITTINGS

Alarm output relay

Item	Specifications
Action	Output relay contacts signal from the back panel of the terminal when alarm occurs
Output points	Up to 24 points
Relay electric shock rating	250VAC(50/60Hz)/3A, 250VDC/0.1A((load resistance))
Output Type	Normal open or normally closed
Relay Operation	OR operation

RS232C/RS485

Item	Specifications
Protocol	MODBUS-RTU
Communication rate	1200/2400/4800/9600/19200/38400/57600 bps
Data length	8 bits
Parity method	None / odd parity / even parity

24VDC Power Distribution

Item	Specifications
Loop	4
Output voltage	22VDC ~ 25VDC (rated output current)
Maximum output current	65mADC(overload protection current: approximately 90mADC)
Allowed Resistence	$\leq 750\Omega$

USB Function

Item	Specifications
USB port	Compatible with USB2.0 protocol
Number of ports	1
Power Supply	5V \pm 10%, 300mA
Devices can be connected	U disk

Analoge signal output

Item	Specification
Output type	4-20mA
Output channel	Up to 8
Allowed Resistance	$\leq 750\Omega$

12.6 GENERAL SPECIFICATIONS.

Frame

Item	Specifications
Installation	Embedded instrument panel installation (vertical plane)
Angle	Allow for a maximum of 30 degrees after the tilt from horizontal
Plate thickness of installation	2 ~ 12 mm
Material	Panels and Terminal Material: ABS plastic Shell: Aluminum alloy
External dimensions	288(W)×288(H)×168(D) (D: the length from the installation panel to terminal)
Weight	About 4 Kg (not including accessories)

Standard operating conditions

Item	Specifications
Supply power Voltage	220VAC
Power Frequency	50Hz
Ambient temperature	0°C ~ 50°C
Environment Humidity	0% ~ 85% (non-condensing)
Warm-up Time	30 minutes after power is switched on
Installation location	Indoor

Power

Item	Specifications
Rated supply voltage	220VAC
Allowed voltage range	85VAC ~ 220VAC
Rated power frequency	50Hz
Started current	≤7.5A
Power consumption	≤109W(including the matching function)

Insulation

Item	Specifications
Resistance voltage	Measurement input terminals: $\geq 400V$
Grounding resistance	Grounding resistance $\leq 10\Omega$

Transportation and storage conditions

Item	Specifications
Ambient temperature	$-10^{\circ}C \sim 60^{\circ}C$
Environment Humidity	$0\% \sim 95\%$ (non-condensing)

Function Standard

Item	Specifications
Display /measurement Accuracy	Standard operating conditions: Temperature: $23 \pm 2^{\circ}C$ Humidity: $55\% \pm 10\%RH$ Supply Voltage: $220VAC$ Power Frequency: $50Hz \pm 1\%$ Warm-up Time: at least 30 minutes Other environmental conditions (e.g. vibration) does not adversely affect the operation Numerical precision: Basic error of full range $\leq 0.2\%F.S.$ Curve Accuracy: $0.5\%F.S.$ $-2VDC \sim +10VDC$
Maximum input voltage	Voltage signal: $\geq 1M\Omega$
Input impedance	Current signal: 250Ω
Resistance voltage	$0.5mA$
measures current	About $2.5\mu A$
Current when checking burnout	$\geq 300VACrms(50Hz)$
Maximum common-mode noise voltage	$5VDC: 1VAC(50Hz)$
Series mode rejection	$100mV: 100mVAC(50Hz)$ $20mV: 50mVAC(50Hz)$

Other criteria

Item	Specifications
Data retention	About 10 years

12.7 EXTERNAL DIMENSION

Unit: mm

Dimensions of the instrument

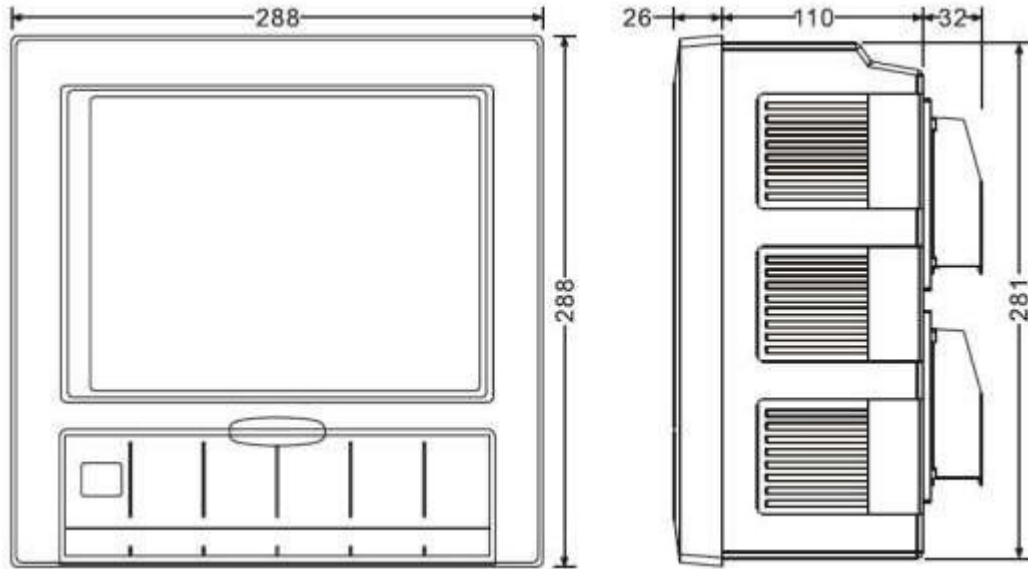

Dimensions of Instrument installation

