

UT301A+/UT302A+/UT303A+ Infrared Thermometer User Manual

Preface

Thank you for purchasing the new infrared thermometer. In order to use this product safely and correctly, please read this manual thoroughly, especially the *Safety Instructions* part.

After reading this manual, it is recommended to keep the manual at an easily accessible place, preferably close to the device, for future reference.

Limited Warranty and Liability

Uni-Trend guarantees that the product is free from any defect in material and workmanship within one year from the purchase date. This warranty does not apply to damages caused by accident, negligence, misuse, modification, contamination and improper handling. The dealer shall not be entitled to give any other warranty on behalf of Uni-Trend. If you need warranty service within the warranty period, please contact your seller directly.

Uni-Trend will not be responsible for any special, indirect, incidental or subsequent damage or loss caused by using this device. As some countries or regions do not allow limitations on implied warranties and incidental or subsequent damages, the above limitation of liability may not apply to you.

Introduction

UT301A+/UT302A+/UT303A+ infrared thermometer (hereinafter referred to as the thermometer) can quickly and accurately determine the surface temperature by measuring the infrared energy radiated from the target surface. It is suitable for non-contact surface temperature measurement.

The D-S ratios are:

UT301A+: 12:1

UT302A+: 20:1



UT303A+: 30:1

Safety Instructions

Warning:

To prevent eye damage or personal injury, please read the following safety instructions before using the thermometer:

- Please do not irradiate people or animals with laser directly or indirectly.
- Please do not look at the laser directly or through other optical tools (telescope, microscope, etc.).

LASER RADIATION DO NOT STARE INTO BEAM  
OUTPUT <1mW COMPLIES WITH EN60825-1:2014

Precautions:

- Do not look directly at the laser emitter.
- Do not disassemble or modify the thermometer or laser.
- To ensure the safety and accuracy of the thermometer, it should only be repaired by a qualified professional using the original replacement parts.
- If the battery symbol on the LCD display is flashing, please replace the battery immediately to prevent inaccurate measurement.
- Inspect the case before using the thermometer. Do not use the thermometer if it appears damaged. Look for cracks or missing plastic.
- Please refer to the emissivity information for the actual temperature. Highly reflective objects or transparent materials can cause the measured temperature value to be lower than the actual temperature.
- When measuring high temperature surfaces, please be aware not to touch them.
- Do not use the thermometer in an environment close to flammable or explosive materials.
- Using the thermometer around steam, dust, or environments with large temperature fluctuations may lead to inaccurate temperature measurement.
- To ensure measurement accuracy, please place the thermometer in the measurement environment for 30 minutes before using.
- Avoid keeping the thermometer near high temperature environment for long periods.

Technical Specifications

Model	UT301A+	UT302A+	UT303A+
D:S ratio	12:1	20:1	30:1
Measuring range	-32°C~-420°C/ -25.6°F~788°F	-32°C~-700°C/ -25.6°F~1292°F	-32°C~-800°C/ -25.6°F~1472°F
LCD size	30mm*30mm	35mm*35mm	35mm*35mm

LCD display	Color EBTN		
Accuracy	<0°C: ±(1.5°C+0.1°C/°C); ≥0°C: ±1.5°C or ±1.5% of reading, whichever is greater <32°F: ±(3.0°F+0.1°F/°F); ≥32°F: ±3.0°F or ±1.5% of reading, whichever is greater		
Temperature coefficient	±0.1°C/°C or ±0.1%/°C, whichever is greater (±0.1°F/°F or ±0.1%/°F, whichever is greater)		
Repeatability	0.7°C or 0.7%, whichever is greater (1.5°F or 0.7%, whichever is greater)		
Emissivity	0.1~1.0 (adjustable, can store 5 sets of preset values)		
Response time	≤250ms (95% of reading)		
Spectral response	8um~14um		
Auto power off	15s		
Low battery indication	✓		
High/Low temperature LED alarm	✓		
High/Low temperature audible alarm	✓		
Data hold	✓		
Unit conversion (°C/°F)	✓		
MAX/MIN/AVG/DIF mode	✓		
Lock measurement	✓		
Laser	Single laser, wavelength 630nm~670nm; output power <1mW, class 2 laser		
Operating temperature	0°C~50°C (32°F~122°F)		
Storage temperature	-20°C~60°C (-4°F~140°F)		
Operating humidity	<RH90% (non-condensing)		
Drop test	1m		
Battery type	9V battery (6F22)		
Battery life	Continuous temperature measurement: ≥9 hours for the alkaline battery; ≥4 hours for the carbon battery		
Product color	Red and grey		
Product net weight	204g	310g	310g
Product size	161.50x90.00x48.00 (mm)	179.00x126.50x53.00 (mm)	179.00x126.50x53.00 (mm)

Safety Standards

CE certification: EN61326-1:2013

Laser safety standard: EN60825-1:2014

Reference Standard

JJG 856-2015

Product Features



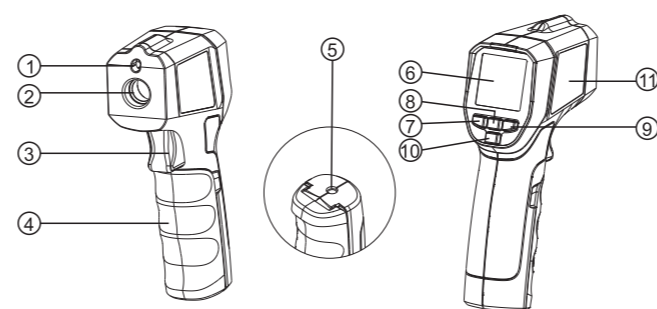

- Precise single laser aiming
- Bright color EBTN display
- MAX/MIN/AVG/DIF value hold
- 5 sets of high/low temperature alarm preset values and 5 sets of emissivity preset values can be stored for users to set up quickly.
- With tricolor (red, green and blue) LED and buzzer alarm functions
- Lock measurement, for processes that require temperature monitoring
- With Tripod mount installation hole

External Structure

1	Laser
2	Infrared sensor
3	Trigger
4	Battery cover
5	Tripod screw hole
6	LCD display
7	MODE button
8	SET button
9	HI/LO button
10	Laser switch button
11	Laser warning label



LCD Description

	Lock measurement indicator
	Buzzer indicator
HI OK LO	Temperature measurement alarm indicator
	Low battery indicator
SCAN	Temperature measurement indicator
HOLD	Temperature hold indicator
°C °F	Temperature unit indicator
8888	Main display of the measured temperature
8888	Auxiliary display of the measured temperature
ε=0.88	Emissivity indication
	Laser indicator
MAX MIN AVG DIF	Measurement mode indication

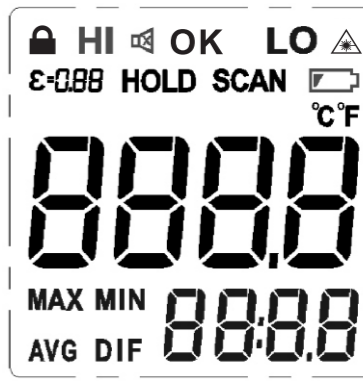

Operating Instructions

Viewing the Last Measured Value

In the off state, short press (less than 0.5s) the trigger to turn on the thermometer and the measurement data held before last shutdown will be displayed. Toggle to view the MAX/MIN/AVG/DIF value by short pressing the MODE button.

Auto Power Off

In the HOLD mode, if there is no operation for 15s, the thermometer will automatically power off and save the currently held measurement.

Manual Measurement



1. Pull and hold the trigger after aiming at the target. The SCAN icon will be flashing indicating that the target object temperature is being measured. The measurement result will be updated on the LCD.
2. Release the trigger, the SCAN icon disappears, and the HOLD icon appears, indicating that the measurement has been stopped and the last measured value is held.

Lock Measurement

Description:

- In the lock measurement function setting interface, the lock measurement time (1 minute to 5 hours) can be set. Refer to *Lock Measurement Setting* for details.
- After time setting, the measurement starts after the activation of the lock function. When the set time is reached, the thermometer will automatically power off and save the last measured value.
- You can view the measured values by short pressing (less than 0.5s) the trigger (NOTE: The measured values will be cleared by long press). This operation is applicable to processes that require regular monitoring of temperature. If no timing is needed, just do not set the time.

Operation:

1. When the lock measurement function is turned on, short press the trigger to enable it. The  icon will appear on the thermometer screen and the SCAN icon will flash. The thermometer will continuously measure the target temperature.
2. Pull the trigger again, the  and SCAN icons disappear, and the HOLD icon appears. The thermometer stops the measurement and holds the last measured value.

NOTE: During measurement, it is best to ensure that the measured target diameter is twice the spot size (S) of the thermometer, and then determine the test distance (D) according to the D:S diagram (refer to D:S part).



For example, if you use the UT301A+ to measure the temperature of an object with a diameter of about 4" (10cm), then according to the above, the spot size (S) of the thermometer should be about 2" (5cm) for highest accuracy, and according to the D:S diagram, the measured distance (D) is about 24" (60 cm).

MAX/MIN/AVG/DIF Value Reading

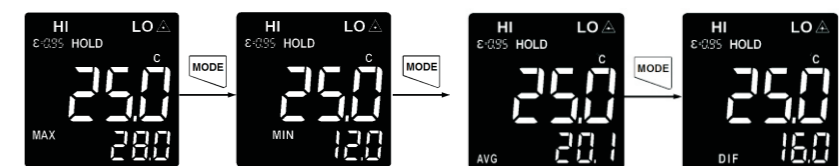
Short press the MODE button to switch the "MAX→MIN→AVG→DIF" measurement mode in turn and the temperature value of the corresponding mode will be shown in the auxiliary display area (as shown below).



Laser Indication Function On/Off

Short press the  button to turn on/off the laser indication function. When it is turned on, the laser indicator  will be displayed on the LCD, and the laser will accurately indicate the position you are measuring during temperature measurement.

NOTE: Please follow the laser precautions when the laser is turned on to avoid damage to human or animal eyes.



High/Low Temperature Alarm On/Off

Short press the HI/LO button to turn the high/low limit alarm function on and off in sequence.

When HI limit alarm function is turned on and the measured temperature value is higher than the set high alarm limit, the red LED and HI indicator flash. If the audible alarm function has been turned on, the buzzer will beep.

When LO limit alarm function is turned on and the measured temperature value is lower than the set low alarm limit, the blue LED and LO indicator flash. If the audible alarm function has been turned on, the buzzer will beep.

When HI/LO limit alarm function is turned on and the measured temperature value is within the high and low alarm limit range, the green LED lights up and the OK indicator is displayed, indicating that the measured temperature is normal.

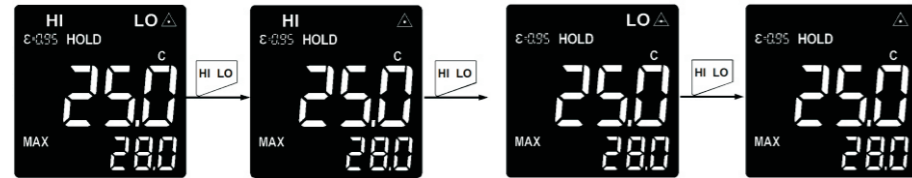

Function Setting

In the HOLD interface, short press the SET button to enter the settings of high alarm limit → low alarm limit → emissivity → temperature unit → audible alarm → lock measurement, etc. In these setting interfaces, pull the trigger or do not operate for 10s to return to the HOLD interface.

High Alarm Limit Setting

In the HOLD interface, short press the SET button once to enter the high alarm limit setting interface. Short press the Δ button to quickly select the preset high alarm limit value (P1-P5). If there is no desired value among the preset values, select any value closest to the high alarm limit, and adjust it by pressing the ∇ button or \blacktriangle button. Add or subtract 1 each time by short press, and add or subtract 10 per second by long press. (see Figure 1)



Figure 1



Figure 2

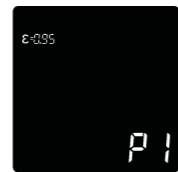

Figure 3

Low Alarm Limit Setting

In the HOLD interface, short press the SET button twice to enter the low alarm limit setting interface, and adjust the low alarm limit value by pressing the ∇ button or \blacktriangle button. Add or subtract 1 each time by short press, and add or subtract 10 per second by long press. (see Figure 2)

Emissivity Setting

In the HOLD interface, short press the SET button until emissivity setting is displayed. Short press the Δ button to quickly select the preset emissivity value (P1-P5). If no desired value among the preset values, select any value closest to the emissivity, and adjust it by pressing the ∇ button or \blacktriangle button. Add or subtract 0.01 each time by short press, and add or subtract 0.1 per second by long press. (see Figure 3)

Temperature Unit Setting

In the HOLD interface, short press the SET button until temperature unit setting is displayed, and switch between °C and °F by pressing the ∇ button or \blacktriangle button.

Audible Alarm Setting

In the HOLD interface, short press the SET button until audible alarm setting is displayed, and turn on/off the audible alarm by pressing the ∇ button or \blacktriangle button.

Lock Measurement Setting

In the HOLD interface, short press the SET button until lock measurement setting is displayed, and turn on/off the lock measurement by pressing the ∇ button or \blacktriangle button. When the lock measurement is turned on, press the Δ button to perform the timing setting "00:00" for the lock measurement. At this time, the selected time position flashes, and the time value can be adjusted by pressing the ∇ button or \blacktriangle button. Set timing to "00:00" to turn off timing function.



D:S (Distance Coefficient)

As the distance (D) from the target being measured to the thermometer increases, the spot size (S) on the measured area becomes larger. The relationship between the distance and the spot size is as shown below.

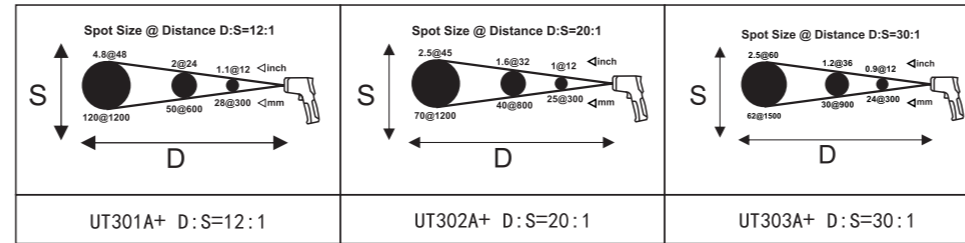

Field of View

Make sure that the measured target is larger than the spot size. The smaller the target, the closer the test distance should be (please refer to D:S for the spot size at different distances). To obtain the optimum measurement result, it is recommended that the target being measured is 2 times larger than the spot size.

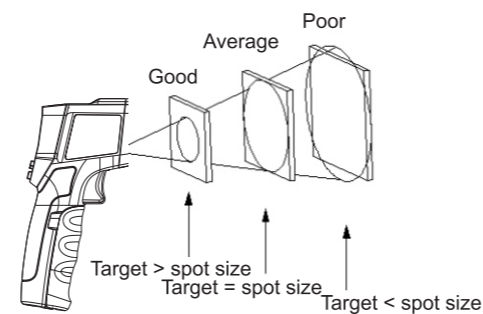

Emissivity

Emissivity is a symbol of the energy radiation of a material. The emissivity of most organic materials and coated or oxidized surfaces is about 0.95. To measure the temperature of a bright metal surface, cover the surface to be tested with masking tape or matt black paint with a high emissivity setting (if it is possible), wait for a period of time, and measure the temperature of the tape or black paint surface when it reaches the same temperature on the surface of the object covered below. The total emissivity of some metals and non-metals are listed in the following table.

Measured Surfaces	Emissivity
Metal	
Aluminum	
Oxidization	0.2-0.4
A3003 Alloy	
Oxidization	0.3
Rough	0.1-0.3
Brass	
Burnishing	0.3
Oxidization	0.5
Copper	
Oxidization	0.4-0.8
Electric Terminal Board	0.6
Hastelloy	
Alloy	0.3-0.8
Inconel	
Oxidization	0.7-0.95
Sand-Blasting	0.3-0.6
Electro Burnishing	0.15
Iron	
Oxidization	0.5-0.9
Rusting	0.5-0.7
Iron (Casting)	
Oxidization	0.6-0.95
Non-Oxidization	0.2
Casting	0.2-0.3
Iron (Forging)	
Passivation	0.9
Lead	
Rough	0.4
Oxidization	0.2-0.6
Molybdenum	
Oxidization	0.2-0.6
Nickel	
Oxidization	0.2-0.5
Platinum	
Black	0.9

Steel	
Cold Rolling	0.7-0.9
Steel Plate Rubbing	0.4-0.6
Steel Plate Burnishing	0.1
Zinc	
Oxidization	0.1
Non-Metal	
Asbestos	0.95
Asphalt	0.95
Basalt	0.7
Carbon	
Non-Oxidization	0.8-0.9
Graphite	0.7-0.8
Silicon Carbide	0.9
Ceramics	0.95
Clay	0.95
Concrete	0.95
Cloth	0.9
Glass	
Convex Glass	0.76-0.8
Smooth Glass	0.92-0.94
Lead-Boron Glass	0.78-0.82
Plates	0.96
Plaster	0.8-0.95
Ice	0.98
Limestone	0.98
Paper	0.95
Plastics	0.95
Water	0.93
Soil	0.9-0.98
Wood	0.9-0.95

Maintenance

Clean

Use clean compressed air to blow away falling particles. Use wet cotton swab to carefully wipe lens surface. Use wet sponge or soft cloth to clean product exterior. Do not rinse the thermometer or immerse it in water.

Battery Replacement

Install or replace a 9V battery (6F22) as follows:

1. Open the battery cover.
2. Insert the battery and pay attention to the polarity.
3. Close the battery cover.

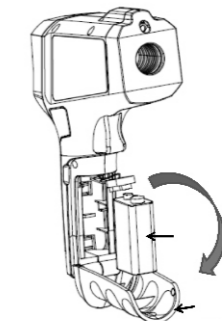

Troubleshooting

Symptom	Problem	Action
OL appears when measuring	Measured value is greater than the maximum range	Stop measuring
-OL appears when measuring	Measured value is less than the minimum range	Stop measuring
Err appears when booting	Exceeding the minimum or maximum operating ambient temperature	Place the thermometer in a 0°C~50°C (32°F~122°F) environment and it can be recovered after 30 minutes
Battery indicator flashes	Low battery	Replace the battery
Laser fails to work / weak laser	Low battery	Replace the battery
The measurement is inaccurate	Emissivity mismatching, measured distance is too far, measured target diameter is less than 20mm, etc.	Please refer to the instructions for field of view, D:S, etc.